

GENERAL NOTES:

THE FOLLOWING TECHNICAL CODES SHALL APPLY:
 2010 FLORIDA BUILDING CODE,
 PLUMBING, MECHANICAL, FUEL GAS,
 ENERGY EFFICIENCY, ACCESSIBILITY,
 AND NATIONAL ELECTRICAL CODES
 NEC 2008

1. TANK TYPE WATER CLOSET VOLUME
1.8 GALLONS
2. WALL MOUNT WATER CLOSET VOLUME
3.5 GALLONS
3. WATER - FLOW RATE.
 PUBLIC FACILITIES 0.5 G.P.M.
 PRIVATE FACILITIES 2.2 G.P.M.
 SHOWER HEADS 2.5 G.P.M.

VTR LOCATIONS ARE APPROXIMATE AND MAY CHANGE DUE TO JOBSITE CONDITIONS

THE FOLLOWING SHALL COMPLY WITH THE 2010 FBC

- PORCHES AND BALCONIES
- HANDRAILS
- GUARDRAILS
- STAIRS
- CHIMNEY & FIREPLACE
- EGRESS WINDOWS

4. ALL OPENINGS SHALL COMPLY WITH 2010 FBC WIND LOADS AS STATED BELOW. ATTACHMENTS OF WINDOWS, DOORS, SLIDING GLASS DOORS AND O.H. GARAGE DOORS ARE DELEGATED THE MANUFACTURER OF THESE ITEMS. THE MANUFACTURER OF THESE ITEMS SHALL SUBMIT ATTACHMENTS TO ENGINEER OF RECORD FOR REVIEW PRIOR TO INSTALLATION. SEE ATTACHED SPECIFICATION SHEETS FOR MANUFACTURERS DESIGN CRITERIA AND INSTALLATION METHODS FOR WINDOWS, DOORS, SLIDING GLASS DOORS, OVERHEAD GARAGE DOORS, AND ROOFING.
5. ALL DOORS INTERIOR & EXTERIOR ARE 8' 0" UNLESS OTHERWISE NOTED
ALL SHOWER ENCLOSURES TO BE TEMPERED GLASS
6. ALL WINDOWS WITHIN 24" OF DOORS (INTERIOR & EXTERIOR) AND WITHIN 18" OFF FLR TO BE TEMPERED GLASS.

ROBBIAN DESIGN
 AL ROBBIAN A.I.B.D.
 6397 CONNEWOOD SQ.
 NEW PORT RICHEY, FL. 34653
 (727) 848-2259
 MAIL:al@robbiandesign.com

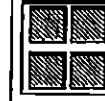

AI BD
 AIBD
 7059 Blair Road NW
 Suite 201
 Washington DC 20012

SOFTPLAN
 ARCHITECTURAL DESIGN SOFTWARE

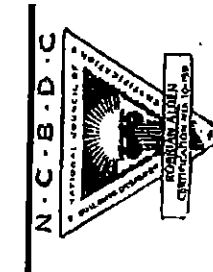

ALLEN ENGINEERING AND CONSTRUCTION SERVICES, INC. (AECS) IS NOT RESPONSIBLE FOR THE ARCHITECTURAL DESIGN, ITS FEATURES AND ASSOCIATED DIMENSIONS. THE ARCHITECTURAL INFORMATION IS ACCEPTED AS BEING ACCURATE AND IS USED BY AECS SOLELY FOR THE PURPOSE OF DETERMINING STRENGTH, FIRE PROTECTION, AND FLOOD RESISTANCE CONSTRUCTION REQUIREMENTS.

INDEX OF DRAWINGS

SHEET	TITLE
S	COVER SHEET
S1	STRUCTURAL ENGINEER NOTES
S2	STRUCTURAL ENGINEER NOTES
S3	STRUCTURAL ENGINEER NOTES
S4	WIND LOAD DESIGN DATA
1	FOUNDATION PLAN
2	FLOOR PLAN NOTES
3	DIMENSION PLAN
4	EXTERIOR ELEVATIONS
4A	ENTRY TOWER DETAILS
5	EXTERIOR ELEVATIONS
6	ROOF PLAN
6A	TRUSS PLAN
6B	ENTRY TOWER TRUSS PLAN
7	ELECTRICAL PLAN
8	CONSTRUCTION DETAILS
9	CONSTRUCTION DETAILS
10	TYPICAL WALL SECTIONS
11	TYPICAL FOOTING DETAILS

NOTICE TO SUBCONTRACTORS :

DUE TO SPACE LIMITATIONS IN THIS 11"X 17" PLAN FORMAT, AND TO ELIMINATE CLUTTER AND TEXT READABILITY ISSUES, SOME DETAILS AND NOTATIONS MAY OR MAY NOT BE LOCATED ON THE SAME SHEETS OR IN THE SAME LOCATIONS AS PROVIDED FOR BY OTHER CONTRACTORS OR ARCHITECTS. IT WOULD BE IN YOUR BEST INTEREST TO REVIEW THESE PLANS AND LOCATE THE APPROPRIATE INFORMATION REQUIRED TO COMPLETE YOUR SPECIFIC PORTION OF THE JOB BEFORE BEGINNING CONSTRUCTION.

NOTICE TO BUILDER

IT IS THE INTENT OF THIS DESIGNER THAT THESE PLANS ARE ACCURATE AND ARE CLEAR ENOUGH FOR THE LICENSED PROFESSIONAL TO CONSTRUCT THIS PROJECT. IN THE EVENT THAT SOMETHING IS UNCLEAR OR NEEDS CLARIFICATION, STOP AND CALL THE DESIGNER LISTED IN THIS TITLE PAGE. IT IS THE RESPONSIBILITY OF THE LICENSED PROFESSIONAL THAT IS CONSTRUCTING THIS PROJECT TO FULLY REVIEW THESE DOCUMENTS BEFORE CONSTRUCTION BEGINS AND ANY AND ALL CORRECTIONS, IF NEEDED, TO BE MADE BEFORE ANY WORK IS DONE.

WINDOW INSTALLATION NOTES:

1. WINDOWS MUST BE FASTENED INTO STRUCTURAL MEMBERS PER MFG'S. DETAIL REQUIREMENTS PER DESIGN CRITERIA NOTED ON THESE DRAWINGS.
2. WINDOWS ARE NOT IMPACT RESISTANT TYPE. STORM SHUTTERS OR PANELS ARE REQUIRED.
3. ROOF, WALLS AND WINDOW FASTENINGS MUST BE ENGINEERED AND SPECIFIED FOR CUMULATIVE INTERNAL PRESSURE AND EXTERNAL NEGATIVE (SUCTION) PRESSURES WHICH VARIES ACCORDING TO AREAS AS NOTED IN THE DESIGN CRITERIA AS NOTED ON PAGE S4.

COVER SHEET



DEEB FAMILY HOMES, LTD.
 9400 RIVER CROSSING BLD.
 NEW PORT RICHEY, FL. 34655
 727-376-6831

PLAN DATE
2-10-2014

INVENTORY
 LOT 40 MAJESTIC OAKS
 PINELLAS COUNTY, FL.

I HEREBY CERTIFY THAT I HAVE REVIEWED THE ATTACHED DESIGN TO COMPLY WITH THE ULTIMATE END USE AND IT IS IN COMPLIANCE WITH SEC. 901 OF THE 2010 FLORIDA RESIDENTIAL BUILDING CODE.
 RICH ALLEN PROFESSIONAL ENGINEER
 RICH ALLEN
 P.E. 14656

ALLEN ENGINEERING & CONSTRUCTION SERVICES
 RICH ALLEN PROFESSIONAL ENGINEER
 P.E. # 56920 C.A. # 9542
 P.O. BOX 151
 NEW PORT RICHEY, FL. 34656
 727-842-6100 Fax: 727-825-5973
 richallenpe@gmail.com

AECS 14014

ASPEN 3503

STRUCTURAL ENGINEER DESIGN NOTES

ADMINISTRATIVE

1. THE ENGINEERING FIRM FOR THIS STRUCTURAL DESIGN IS ALLEN ENGINEERING AND CONSTRUCTION SERVICES, INC. HEREBIN REFERRED TO AS "AECS" OR "A.E.C.S."
2. THE ENGINEER FOR THIS STRUCTURAL DESIGN IS RICHARD E. ALLEN, PE, HEREBIN REFERRED TO AS "STRUCTURAL ENGINEER".
3. THE STRUCTURAL ENGINEER DESIGN NOTES ARE PART OF THE STRUCTURAL DESIGN AND ARE TO BE TAKEN AS TYPICAL REQUIREMENTS UNLESS NOTED OTHERWISE, "UNO", IN THE STRUCTURAL PLANS AND STRUCTURAL DETAILS.
4. THE DESIGN SHOWN IN THESE PLANS CONFORMS TO THE STRUCTURAL PROVISIONS OF THE CHAPTER 16 OF THE FLORIDA BUILDING CODE, SECTION R301 OF THE FLORIDA RESIDENTIAL BUILDING CODE 2010, THE SECTIONS TITLED "STRUCTURAL" OF THE FLORIDA EXISTING BUILDING CODE 2010.
5. THE PURPOSE OF THESE PLANS IS TO OBTAIN A BUILDING PERMIT AND FOR SUBSEQUENT CONSTRUCTION OF THE DESIGN AS SHOWN. THESE PLANS ARE TO BE CONSIDERED VOID IF WORK COMMENCES PRIOR TO A PERMIT BEING ISSUED, A CHANGE IN THE BUILDING CODE OCCURS PRIOR TO THE PLANS BEING SUBMITTED FOR PERMIT OR AFTER SIX MONTHS OF THE DATE THAT THESE PLANS ARE SIGNED AND SEALED WITHOUT BEING SUBMITTED FOR PERMITTING, WHICHEVER OCCURS FIRST. ONCE A BUILDING PERMIT HAS BEEN ISSUED BASED ON THESE PLANS, THE BUILDING DEPARTMENT IS NOT AUTHORIZED TO REISSUE OR TRANSFER BUILDING PERMITS WITHOUT THE EXPRESSED WRITTEN CONSENT OF THE STRUCTURAL ENGINEER.
6. CONSTRUCTION BASED ON THE STRUCTURAL DESIGN IS TO BE DONE AS SHOWN IN THE PLANS WITHOUT DEVIATION, CHANGE, OR OMISSION WITHOUT PRIOR APPROVAL OF THE STRUCTURAL ENGINEER. IF ADDITIONAL DETAIL INFORMATION, OR EXPLANATION IS NEEDED, IT IS TO BE OBTAINED FROM THE STRUCTURAL ENGINEER. THE STRUCTURAL ENGINEER IS NOT RESPONSIBLE FOR ANY PART OF THESE PLANS, INCLUDING PROVISIONS AS STATED IN ITEM 4.

7. IT IS IMPORTANT TO UNDERSTAND THAT THE STRUCTURAL PROVISIONS OF THE BUILDING CODE ARE COMPLICATED AND THESE PLANS ARE INTENDED TO BE USED BY AND EXPERIENCED BUILDING CONTRACTOR. PROPERTY OWNERS OBTAINING OWNER-BUILDER PERMITS ARE PROCEEDING AT THEIR OWN RISK. THE STRUCTURAL ENGINEER IS NOT RESPONSIBLE FOR ANY ERRORS OR OMISSIONS BY PROPERTY OWNERS OR THEIR AGENTS AS A RESULT OF ANY MISUNDERSTANDING OF THE PLANS THAT OTHERWISE WOULD BE UNDERSTOOD BY A LICENSED CONTRACTOR.
8. THE STRUCTURAL ENGINEER IS NOT RESPONSIBLE FOR CONSTRUCTION MEANS, METHODS, AND SCHEDULE.
9. THE STRUCTURAL PLANS AND ANY RELEVANT DESIGN DOCUMENTS PRODUCED UNDER THE DIRECT CHARGE OF THE STRUCTURAL ENGINEER ARE THE PROPERTY OF THE STRUCTURAL ENGINEER AND MAY NOT BE USED BY ANY PERSON OTHER THAN THE CONTRACTED CLIENT AND FOR ANY PURPOSE OTHER THAN THAT STATED IN ITEM 5 ABOVE WITHOUT THE EXPRESSED WRITTEN CONSENT OF THE STRUCTURAL ENGINEER. MOREOVER, NO OTHER ENGINEER OR ARCHITECT IS TO BE DESIGNATED A DELEGATED ENGINEER FOR ANY PURPOSE RELATED TO THESE STRUCTURAL PLANS OR CONSTRUCTION BASED ON THESE PLANS PRIOR TO THE ISSUANCE OF A CERTIFICATE OF COMPLETION OR OCCUPANCY WITHOUT THE EXPRESSED WRITTEN CONSENT OF THE STRUCTURAL ENGINEER.

DESIGN CRITERIA

10. LOAD COMBINATIONS: THIS DESIGN IS BASED ON AN "ALLOWABLE-STRESS" FORMULATION RELYING ON THE LOAD COMBINATIONS DEFINED IN FBC 2010 SECTION 1605.3.1 OR SECTION 1605.3.2 WHERE OMEGA EQUALS 1.3.
11. FOUNDATION LOADS: SEE NOTES ON "SITE CONDITIONS, SOILS, AND FOUNDATIONS."
12. FLOOR LIVE LOADS:
 - A. RESIDENTIAL ONE AND TWO FAMILY DWELLINGS: ALL LIVE LOADS PER TABLE R301.5: UNINHABITABLE ATTICS WITHOUT STORAGE: 10 PSF UNINHABITABLE ATTICS WITH STORAGE: 20 PSF

HABITABLE ATTICS AND SLEEPING AREAS: 30PSF
BALCONIES: 60 PSF
DECKS: 40 PSF

13. STAIRS INFORMATION CONTAINED ON A PLANS SHEET WHERE HIS SIGNATURE AND SEAL APPEAR, THAT DOES NOT PERTAIN TO THE RELEVANT STRUCTURAL PROVISIONS AS STATED IN ITEM 4, INCLUDING BUT NOT LIMITED TO THE BUILDING OCCUPANCY, THE ARCHITECTURAL DESIGN, ITS FEATURES, FINISHES (E.G. DECORATIVE STUCCO, SIDING, ROOFING, SOFFITS, FLASHING, PAINTING ETC) AND THEIR INSTALLATION, DIMENSIONS, AND ANY DESIGN OF FIRE PROTECTION, ELECTRICAL, PLUMBING, AND MECHANICAL COMPONENTS OR SYSTEMS.
- THE ARCHITECTURAL INFORMATION, INCLUDING DIMENSIONS, SHOWN IN THESE PLANS AND PROVIDED TO THE STRUCTURAL ENGINEER BY OTHERS IS PRESUMED ACCURATE AND IS RELIED UPON BY THE STRUCTURAL ENGINEER SOLELY FOR THE PURPOSE OF ACHIEVING COMPLIANCE WITH THE RELEVANT STRUCTURAL ALL OTHER ROOMS: 40 PSF
- GUARDRAILS/HANDRAILS: 200 LB CONCENTRATED LOAD APPLIED IN ANY DIRECTION
 - A. COMMERCIAL ALL LIVE LOADS PER FBC 2010 TABLE 1607.1
 14. ROOF LIVE LOADS ALL ROOF WOOD CONSTRUCTION TYPES ARE 30 PSF
 15. DEAD LOADS FLOOR WOOD FRAME: 35 PSF FOR TILE/MARBLE FLOOR COVERING, 15 PSF FOR ALL OTHER ROOF WOOD FRAME: 25 PSF FOR SHINGLES, 35 PSF FOR TILE
 16. WIND LOADS
 - A. WIND LOADS ARE BASED ON THE SPECIFIC REQUIREMENTS AND DEFINITIONS OF FLORIDA RESIDENTIAL BUILDING CODE 2010 EDITION ASCE 7-10
 - B. THE COMPONENT AND CLADDING WIND PRESSURES ARE THE MINIMUM REQUIREMENTS FOR STRENGTH AND IMPACT PROTECTION NEEDED FOR SELECTING SATISFACTORY COMPONENTS AND CLADDING, BY OTHERS, FOR THE STRUCTURE.

- SITE CONDITIONS**
18. SITE PLAN AND TOPOGRAPHY
 - A. THE STRUCTURAL ENGINEER IS NOT A SURVEYOR AND IS NOT RESPONSIBLE FOR THE SITE PLAN, ESTABLISHING REQUIRED SET-BACKS, AND LOCATING THE BUILDING ON THE PROPERTY.
 - B. THE STRUCTURAL ENGINEER IS NOT RESPONSIBLE FOR THE GRADING OF THE SITE OR ITS COMPLIANCE WITH ANY DRAINAGE PLAN WHETHER INDIVIDUAL OR AS PART OF A MASTER DRAINAGE PLAN.
 - C. ELEVATIONS. THE FOUNDATION DESIGN IS BASED ON THESE PRESUMED CONDITIONS INCLUDING THAT DIFFERENTIAL SETTLING DOES NOT EXCEED THE SAFE LIMITS OF THE FOUNDATION DESIGN (INCLUDING STEMWALLS AND MASONRY ABOVE GRADE WALLS) AS STATED IN ITEM 19.3 BELOW.
 - D. IT IS IMPORTANT TO KNOW THAT THE FOUNDATION DESIGN BASED ON A PRESUMED ALLOWABLE SOIL BEARING CAPACITY OF 2,000 PSF RELIES ON LESS THAN L/500 (E.G. 0.25 INCHES OVER 10 FEET) OF DIFFERENTIAL SETTLEMENT. CRACKS IN MASONRY WALLS SHOULD BE EXPECTED WHERE DIFFERENTIAL SETTLEMENT EXCEEDS L/300 (E.G. 0.4 INCHES OVER 10 FEET) AND STRUCTURAL DAMAGE SHOULD BE EXPECTED WHERE DIFFERENTIAL SETTLEMENT EXCEEDS L/150. THIS STATEMENT SHOULD BE TAKEN AS A CAUTIONARY NOTE FOR PROCEEDING WITHOUT A SOILS ANALYSIS AND FOUNDATION RECOMMENDATION BY A GEOTECHNICAL ENGINEER FOR THE SITE.
 - E. COPIES OF ANY AND ALL REQUIRED COMPACTION TESTS ARE TO BE PROVIDED TO THE BUILDING DEPARTMENT FOR THEIR RECORDS.

- STRUCTURAL ELEMENTS**
19. FOUNDATION, FOOTINGS, AND GROUND FLOOR SLAB
 - A. THE FOUNDATION AND FOOTINGS ARE TO BEAR A MINIMUM OF 12 INCHES BELOW GRADE AND ARE TO BE PLACED ON UNDISTURBED SOIL OR FILL COMPACTED TO A MINIMUM OF 95% MODIFIED PROCTOR PURSUANT TO ASTM D 1557 WITH FILL LIFTS LESS THAN 12".

20. FOOTINGS (AND ANY ASSOCIATED MONOLITHIC FLOOR SLAB) SHALL BE CONSTRUCTED OF CONCRETE WITH A SPECIFIED COMPRESSIVE STRENGTH OF 3,000 PSI, 3 TO 5 INCH SLUMP, AND 3/8" AGGREGATE SOILS

- A. IN ADDITION, THE STRUCTURAL ENGINEER IS NOT A CIVIL OR GEOTECHNICAL ENGINEER AND IS NOT RESPONSIBLE FOR DETERMINING THE SUITABILITY OF THE SITE FOR CONSTRUCTION, INCLUDING ITS TOPOGRAPHY, DRAINAGE, AND SUB-SURFACE CONDITIONS (INCLUDING WATER TABLE DEPTH), AND FOR INTERPRETING GEOTECHNICAL DATA CONCERNING THE SITE.
- B. IF THE SOIL CONDITIONS AT THE SITE APPEAR QUESTIONABLE AS DETERMINED BY THE BUILDING CONTRACTOR OR OWNER-BUILDER, A SOILS ANALYSIS SHALL BE PERFORMED BY A LICENSED GEOTECHNICAL ENGINEER THAT WILL GIVE SPECIFIC RECOMMENDATIONS FOR A FOUNDATION TYPE. IF THE BUILDING CONTRACTOR OR OWNER-BUILDER DO NOT MAKE THAT DETERMINATION AND A SOILS ANALYSIS IS NOT PERFORMED, THE STRUCTURAL ENGINEER SHALL PROCEED WITH THE DESIGN BASED ON THE PRESUMPTIONS ALLOWED BY THE FBC 2010, SECTION 1804.
- C. THE DETERMINATIONS OF THE SUITABILITY OF THE SITE FOR CONSTRUCTION (INCLUDING TOPOGRAPHICAL INFORMATION) AND THE SOIL CONDITIONS SHALL HAVE BEEN COMPLETED AND ANY RECOMMENDATIONS RESULTING FROM THAT ANALYSIS SHALL HAVE BEEN PROVIDED TO THE STRUCTURAL ENGINEER PRIOR TO THE SIGNING AND SEALING OF THE STRUCTURAL PLANS.
- D. IN THE ABSENCE OF GEOTECHNICAL INFORMATION, THE SITE IS PRESUMED TO HAVE AN ALLOWABLE SOIL BEARING CAPACITY OF 2000 PSF, AND THE TOPOGRAPHY AS IT RELATES TO THE STRUCTURE IS PRESUMED TO BE THAT SHOWN IN THE ARCHITECTURAL.
- E. THE SIZE AND REQUIRED REINFORCEMENT FOR THE FOOTINGS ARE SHOWN IN THE FOUNDATION PLAN.
- I. THE GROUND FLOOR SLAB SHALL BE PLACED OVER A 6 MIL POLYETHYLENE MOISTURE RETARDER TRUSS SYSTEM ENGINEERS OF THE TRUSS MANUFACTURER IN DEVELOPING THE ACTUAL FLOOR TRUSS SYSTEM DESIGN. IT IS NOT TO BE USED

FOR ANY OTHER PURPOSE AS IT IS SUBJECT TO ENGINEERING AND MAY BE DIFFERENT FROM THE FINAL DESIGN.

- II. MANUFACTURED FLOOR TRUSSES SHALL BE DESIGNED BY A LICENSED TRUSS COMPONENT AND TRUSS SYSTEM ENGINEER ACTING AS A DELEGATED ENGINEER AND WORKING THROUGH A TRUSS MANUFACTURER FOR THIS PURPOSE. THE SELECTION OF THE TRUSS MANUFACTURER IS HEREBY SUBORDINATED TO THE BUILDING CONTRACTOR.
- III. THE MANUFACTURED TRUSS DESIGN SHALL INCLUDE SPECIFYING THE TRUSS TO TRUSS AND TRUSS TO GIRDER CONNECTIONS ON EITHER THE INDIVIDUAL TRUSS COMPONENT SHEETS OR THE GIRDER TRUSS COMPONENTS SHEETS AS APPLICABLE. A SPECIFIC HANGER MUST BE SELECTED AND IDENTIFIED ON THE SIGNED AND SEALED COMPONENT SHEETS FOR EACH LOCATION A HANGER IS REQUIRED IN THE TRUSS SYSTEM.
- IV. THE TRUSS PLAN SIGNED AND SEALED BY THE DELEGATED ENGINEER SHALL BE PROVIDED TO AND REVIEWED BY THE STRUCTURAL ENGINEER FOR COMPLYING WITH THE DESIGN INTENT OF THE ORIGINAL PLAN AND FOR ANY CHANGES TO THE "TRUSS TO UNDERLYING STRUCTURE" CONNECTIONS. THIS PLAN MUST BE PROVIDED TO THE STRUCTURAL ENGINEER PRIOR TO CONSTRUCTION OF THE UNDERLYING STRUCTURE AS THE STRUCTURAL ENGINEER RESERVES THE RIGHT TO MAKE STRUCTURAL CHANGES BASED UPON THE FINAL FLOOR TRUSS SYSTEM.
- F. CONVENTIONAL FRAMED JOISTS WITH MINIMUM 6 INCH OVERLAPS OF JOINTS.
- G. TERMITES TREATMENT OF THE SITE SHALL BE SPECIFIED BY THE BUILDING CONTRACTOR OR OWNER-BUILDER.
- H. SHRINKAGE CONTROL OF THE FLOOR SLAB SHALL BE ACCOMPLISHED BY 6 INCH BY 6 INCH, W1.4 BY W1.4 WELDED WIRE FABRIC AS SPECIFIED BY FBC 2010 SECTION 1910.2, EXCEPTION 2 OR FIBERMESH ADMIXTURE AS SPECIFIED BY FBC 2010, SECTION 1910.2 EXCEPTION 1. THE WELDED WIRE FABRIC SHALL BE PLACED BETWEEN THE MIDDLE AND UPPER 1/3 DEPTH OF THE SLAB AND HELD IN POSITION BY APPROPRIATE SUPPORTS SPACED NOT GREATER THAN 3 FEET APART.
- I. CONTRACTION JOINTS ARE TO BE PROVIDED FOR THE PURPOSE OF CONTROLLING SHRINKAGE. ONE INCH DEEP CUTS

STRUCTURAL ENGINEER NOTES

ASPEN 3503

AECS 14014

ALLEN ENGINEERING & CONSTRUCTION SERVICES
RICH ALLEN PROFESSIONAL ENGINEER
P.E. # 56920 C.A. # 9542
P.O. BOX 151
NEW PORT RICHEY, FL 34654
727-342-6100 Fax: 727-825-3973
richallenpe@gmail.com

I HEREBY CERTIFY THAT I HAVE PERFORMED THE ATTACHED DESIGN TO COMPLY WITH ALL APPLICABLE LAWS, RULES AND IT IS MY BEST JUDGMENT THAT THE DESIGN COMPLIES WITH ALL APPLICABLE REGULATORY REQUIREMENTS AS SPECIFIED BY THE CLIENT.
RICHARD E. ALLEN, P.E.
RICHARD E. ALLEN, P.E. 14014

INVENTORY
LOT 40 MAJESTIC OAKS
PINELLAS COUNTY, FL.

PLAN DATE	2-10-2014
-----------	-----------

DEEB FAMILY
HOMES, LTD.
9400 RIVER CROSSING BLD.
NEW PORT RICHEY, FL 34655
727-376-6831



(FOR A FOUR INCH THICK SLAB OR 25 PERCENT OF THE SLAB THICKNESS OTHERWISE) ARE TO BE PROVIDED ACROSS THE WIDTH AND LENGTH OF ANY FLOOR SLAB AT A DISTANCE NOT TO EXCEED 30 TIMES THE SLAB THICKNESS. FOR EXAMPLE FOR A FOUR INCH THICK SLAB, CONTRACTION JOINTS SHALL NOT EXCEED 10 FEET ON CENTER EACH WAY. THE CONTRACTION JOINTS ARE OPTIONAL FOR ONE AND TWO FAMILY RESIDENTIAL WHEN WELDED WIRE FABRIC OR FIBERMESH ARE USED IN THE FLOOR SLAB.

21. FLOORS
 - A. MANUFACTURED WOOD TRUSSES
 - B. THE MANUFACTURED FLOOR TRUSS FRAMING PLAN CONTAINED HEREIN IS FOR THE ONE PURPOSE OF ILLUSTRATING THE DESIGN INTENT AND FOR PLANNING TO BE USED BY THE TRUSS COMPONENT AND
 - I. FLOOR JOISTS ARE SIZED BASED ON THE SOUTHERN PINE COUNCIL SPAN TABLES FOR NO. 2 GRADE DIMENSIONAL LUMBER.
 - II. FLOOR JOISTS FOR EXTERIOR DECKS SHALL BE PRESSURE TREATED.
 - C. FOR ALL WOOD FLOORS
 - I. THE TRUSS TO WALL CONNECTIONS ARE IDENTIFIED ON THE FLOOR FRAMING PLAN.
 - II. A STRUCTURAL WOOD BAND JOIST IS TO BE PROVIDED ON THE EXTERIOR PERIMETER OF ALL BOTTOM BEARING FLOOR TRUSSES AND JOISTS. THE STRUCTURAL BAND JOIST IS TO BE FASTENED TO EACH END OF A FLOOR TRUSS OR JOIST WITH A SIMPSON L50 BRACKET USING SIMPSON SHORT 10D COMMON NAILS.
 - III. FLOOR TRUSSES OR JOISTS BEARING ON WOOD WALLS ARE TO BE SET WITH A MINIMUM OF THREE 10D COMMON NAILS (TOE NAILED) TO THE TOP PLATE OF THE WALL.
 - IV. A MOISTURE BARRIER SHALL BE INSTALLED BETWEEN ANY UNTREATED WOOD TRUSSES OR JOISTS AND CONCRETE OR MASONRY.
 - V. LEDGERS/NAILERS SHALL BE FASTENED TO WOOD STUDS OR BAND JOISTS (NOT SHEATHING) WITH A MINIMUM OF 2- 3/8" X 5 1/2" LAG BOLTS WITH WASHERS AT EACH STUD INTERSECTION OR 16 INCHES ON CENTER AND SHALL CONSIST OF PRESSURE TREATED LUMBER 2 PLY 1 1/2" THICK BY A HEIGHT AS SHOWN IN THE PLANS. FOR CONCRETE OR MASONRY WALLS THE

FASTENERS SHALL BE 5/8 INCH BY 5 1/2 INCH SIMPSON TITEN HD CONCRETE BOLTS.

- VI. FLOOR BEAMS
 1. BEAMS SUPPORTING FLOOR TRUSSES AND JOISTS ARE TO BE ATTACHED AS SPECIFIED IN THE FLOOR FRAMING PLAN
 2. UNDER NO CIRCUMSTANCES ARE THERE TO BE BUTT JOINTS BETWEEN THE BEARING POINTS OF ANY PLY OF A MULTIPLE BEAM. THE PLIES ARE TO BE CONTINUOUS BETWEEN BEARING POINTS.
 3. MULTIPLE BEAMS CONSISTING OF MANUFACTURED WOOD (E.G. GLULAM, MICROLAM) ARE TO HAVE THE INDIVIDUAL PLIES INTERCONNECTED AS REQUIRED BY THE MANUFACTURER'S SPECIFICATIONS.
 4. MULTIPLE BEAMS CONSISTING OF DIMENSIONAL LUMBER ARE TO HAVE THE INDIVIDUAL PLIES INTERCONNECTED AS FOLLOWS:
 - A. FOR TWO PLY BEAMS - ONE ROW OF 10D GALVANIZED COMMON NAILS AT 6" O.C. ON EACH SIDE OF THE BEAM.
 - B. FOR THREE PLY BEAMS - TWO ROWS OF 16D GALVANIZED COMMON NAILS SPACED AT 6" O.C. (TOP AND BOTTOM) THRU EACH SIDE OF THE BEAM
 - C. FOR FOUR PLY BEAMS AND LARGER - TWO ROWS OF 1/2 INCH DIAMETER CARRIAGE BOLTS OR ALL THREAD ROD WITH NUTS AND WASHERS SPACED AT 12 INCHES ON CENTER 2 INCHES FROM THE TOP AND BOTTOM EDGES OF THE BEAM.
 - D. FLOOR SHEATHING:
 - I. ALL FLOOR SHEATHING IS TO BE 1/2 INCH TONGUE AND GROOVE PLYWOOD RATED FOR FLOOR SHEATHING APPLICATION
 - II. FLOOR SHEATHING SHALL BE FASTENED TO THE FLOOR TRUSSES/JOISTS WITH 10D RING SHANK NAILS AT 6" ON CENTER WITH CONSTRUCTION GRADE ADHESIVE.
 - III. FLOOR SHEATHING SPECIFIED FOR SEALED EXTERIOR DECKS AND ITS INSTALLATION SHALL BE THE SAME AS THAT FOR INTERIOR APPLICATION EXCEPT PRESSURE TREATED AND THE FASTENERS SHALL BE GALVANIZED.
 - E. EXTERIOR DECK FLOORING
 - I. DECK FLOORING SHALL BE INDIVIDUALLY SPECIFIED ON THE FLOOR FRAMING PLANS AND SHALL BE FASTENED TO THE UNDERLYING PRESSURE TREATED JOIST WITH 3 - 3 INCH DECK SCREWS AT EACH FLOORING/JOIST INTERSECTION.

22. WALLS

- A. MASONRY
 - I. CONCRETE MASONRY UNITS (CMU) SHALL HAVE A MINIMUM COMPRESSIVE STRENGTH OF 1900 PSI
 - II. WALL CMU SHALL BE 8 INCH BY 8 INCH X 16 INCH IN SIZE OR 8 INCH X 8 INCH X 8 INCH FOR EDGE FINISHES.
 - III. CMU SHALL BE PLACED IN A RUNNING BOND AND THERE SHALL BE NO VERTICAL BUTT JOINTS EXCEPT AS SHOWN ON THE FLOOR PLAN FOR CONSTRUCTION JOINTS.
 - IV. REINFORCED FILLED CELLS AS SHOWN IN THE PLANS SHALL BE FILLED WITH A "FINE" GRADE GROUT, HAVE A MINIMUM COMPRESSIVE STRENGTH OF 3,000 PSI, AND 8 TO 11 INCH SLUMP TO ENSURE CONSOLIDATION.
 - V. BOND BEAMS SHALL BE POURED WITH GROUT MONOLITHICALLY WITH THE FILLED WALL CELLS - NO COLD JOINTS.
 - VI. VERTICAL STEEL REINFORCEMENT SHALL BE CONTINUOUS BETWEEN THE MIDDLE AND BOTTOM 1/3 OF THE FOOTING HEIGHT AND END IN THE TOP COURSE OF THE BOND BEAM WITH A STANDARD 10 INCH 90 DEGREE BEND.
 - VII. HORIZONTAL REINFORCING STEEL SHALL BE CONTINUOUS, INCLUDING AROUND CORNERS.
 - VIII. REINFORCING STEEL SPLICES SHALL CONSIST OF WIRE LAPS NO LESS THAN 40 TIMES THE STEEL BAR DIAMETER (E.G. 25 INCHES FOR #5 REBAR, 35 INCHES FOR #3 REBAR, AND 52 INCHES FOR #7 REBAR).
- B. WOOD FRAME WALLS
 - I. WALL STUD SIZES ARE SHOWN IN THE TYPICAL WALL SECTION
 - II. LOAD BEARING
 1. WOOD STUDS IN WALLS SHALL BE SPACED AT 16 INCHES ON CENTER AND FASTENED TO THE TOP AND BOTTOM PLATES PER THE TOP PLATE SPlice DETAIL. ALL LOAD BEARING STUDS TO BE SOUTHERN YELLOW PINE #2 GRADE OR BETTER.
 2. LOAD BEARING WALLS SHALL HAVE A SINGLE BOTTOM PLATE (PRESSURE TREATED IN CONTACT WITH MASONRY OR CONCRETE) AND A DOUBLE TOP PLATE. SEE THE TOP PLATE SPlice DETAIL FOR TOP PLATE NAILING AND SPlicing REQUIREMENTS.
 3. THE WOOD STUDS SHALL HAVE A SIMPSON SP2 AT THE TOP PLATE AND A PROPERLY SIZED SPH FOR THE BOTTOM PLATE (E.G. 4" STUD WALL = SPH4, 6" STUD WALL = SPH6)
 4. A 3 STUD PACK SHALL BE INSTALLED DIRECTLY BENEATH BEARING POINTS OF ALL GIRDERS AND BEAMS HAVING GRAVITY LOADS OF UP TO 3000 LBS.
 5. STEEL TUBE COLUMNS SHALL BE INSTALLED IN THE WALL DIRECTLY BENEATH GIRDERS AND BEAMS HAVING GRAVITY LOADS GREATER THAN 3000 LBS.
 6. BASE PLATES SHALL BE FASTENED TO MONOLITHIC FOOTINGS WITH 5/8 INCH BY 8 INCH ANCHOR BOLTS OR SIMPSON TITEN HD CONCRETE BOLTS OF THE SAME SIZE AT 24 INCHES ON CENTER. ALL CONNECTIONS SHALL BE MADE WITH 3 INCH SQUARE BY 1/8 INCH THICK WASHERS.
 7. BASE PLATES BEARING ON WOOD SHALL BE FASTENED WITH 16D COMMON NAILS AT 8 INCHES ON CENTER THROUGH ANY FLOOR SHEATHING AND TO UNDERLYING LUMBER (NOT SHEATHING ONLY AND USE BLOCKING AS NEEDED TO MAINTAIN NAILING SPACING REQUIREMENT.
 8. FOR EXTERIOR LOAD BEARING WALLS, EACH STUD ABOVE THE BASE PLATE SHALL BE FASTENED TO THE UNDERLYING BAND JOIST OR BEAM WITH A SIMPSON LSTA 18 STRAP. FOR THIS SITUATION THE SIMPSON SPH BRACKET TO THE BASE PLATE MAY BE OMITTED.
 9. FOR INTERIOR LOAD BEARING WALLS, 1/2 INCH ALL THREAD ROD SHALL BE INSTALLED AT 32" O.C. FROM THE BASE PLATE THROUGH THE SHEATHING AND TOP PLATE OF UNDERLYING SUPPORTING WALL. ALL CONNECTIONS SHALL INCLUDE A STANDARD 3 INCH SQUARE WASHER.
 10. HEADER BEAMS SHALL BE SIZED ACCORDING TO THE ENCLOSED HEADER SCHEDULE AND FASTENED WITH A MINIMUM OF TWO SIMPSON LSTA 36 STRAPS OVER THE EACH END TO THE JACK STUDS BELOW. IN ADDITION, THE HEADER BEAMS SHALL BE FASTENED WITH A MINIMUM OF 3-10D COMMON NAILS (TOE NAILED ON EACH SIDE AT EACH END TO THE ABUTTING FULL LENGTH STUDS.
- III. NON-LOAD BEARING WALLS
 1. WOOD STUDS IN WALLS SHALL BE SPACED AT 16 INCHES ON CENTER AND FASTENED TO THE TOP AND BOTTOM PLATES WITH A MINIMUM OF THREE 10D COMMON NAILS. NAILS

INSTALLED IN PRESSURE TREATED WOOD SHALL BE GALVANIZED.

2. NON LOAD BEARING WALLS SHALL HAVE A SINGLE BOTTOM PLATE (PRESSURE TREATED AGAINST MASONRY AND CONCRETE) AND A SINGLE TOP PLATE.
3. BASE PLATES SHALL BE FASTENED TO CONCRETE SLABS WITH 1/2 INCH BY 3 1/2 INCH TAPCON SCREWS AT 12" ON CENTER.
4. BASE PLATES ON WOOD SHALL BE FASTENED WITH 16D COMMON NAILS AT 8 INCHES ON CENTER.
- C. SHEATHING
 1. PLYWOOD SHEATHING
 - I. EXTERIOR WALL SHEATHING COVERED BY AN ARCHITECTURAL FINISH SHALL BE MINIMUM 7/16 INCH THICK (NOMINAL) 4 PLY PLYWOOD MANUFACTURED WITH EXTERIOR GLUE.
 2. THE LONG SIDE OF THE SHEATHING SHALL BE INSTALLED PERPENDICULAR TO THE WALL STUDS.
 3. FASTEN TO STUDS AND BLOCKING WITH 8D RING SHANK NAILS AT 4 INCHES ON CENTER ALL LOCATIONS.
 4. IN ADDITION TO THE REGULAR FASTENING, A 2ND ROW SHALL BE INSTALLED AT THE DOUBLE TOP PLATE AND TO THE LOWEST HORIZONTAL WOOD MEMBER ON AN EXTERIOR WALL (E.G. SILL PLATE, BAND JOIST)
 5. FOR PLYWOOD SHEATHING COVERED WITH A CEMENTITIOUS EXTERIOR FINISH, ALL BUTT JOINTS NOT ON WALL STUDS SHALL BE BLOCKED WITH 2X BLOCKING TOE NAILED AT EACH END TO THE WALL STUDS WITH 3-8D COMMON NAILS.
 - II. PARTICLE BOARD
 1. PARTICLE BOARD IS NOT TO BE USED WITH THE EXPRESS WRITTEN CONSENT OF THE STRUCTURAL ENGINEER AND THE PROPERTY OWNER.
 2. THE USE OF PARTICLE BOARD SHEATHING WILL RESULT IN LESS SHEAR STRENGTH AND MAY REQUIRE A REDESIGN OF THE WALL SYSTEM IF A REQUEST OR SUBSTITUTION IS MADE.
- D. ARCHITECTURAL FINISHES
 - I. ARCHITECTURAL WALL FINISHES, SUCH AS STUCCO, CEMENTITIOUS COATINGS, SIDING OR PAINT ARE MENTIONED HERE ONLY FOR THE PURPOSE OF UNDERSTANDING THAT THEIR

INSTALLATION AND ASSOCIATED DETAILS ARE NOT THE RESPONSIBILITY OF THE STRUCTURAL ENGINEER.

23. COLUMNS
 - A. CONCRETE / MASONRY COLUMNS
 - I. MASONRY COLUMNS SHALL BE CONSTRUCTED OF PLASTER CONCRETE BLOCK OR FORMED AND POURED. WALL BLOCK SHALL NOT BE USED FOR MASONRY COLUMNS.
 - II. REINFORCING STEEL SHALL BE GRADE 60 AND HELD IN PLACE BY STIRRUPS SPACED AT 12 INCHES ON CENTER VERTICALLY.
 - III. PLASTER BLOCK COLUMNS SHALL BE FILLED WITH A FINE GROUT HAVING A MINIMUM OF COMPRESSIVE STRENGTH OF 3,000 PSI.
 - IV. FORMED AND POURED COLUMNS SHALL CONSIST OF A MINIMUM OF 3,000 PSI CONCRETE, OR IN AREAS OF HIGH CHLORIDES SUCH AS NEAR THE COAST OR BODIES OF SALT WATER, THE MINIMUM SHALL BE 5,000 PSI.
 - V. ALL MASONRY COLUMNS SHALL BEGIN AT THE FOUNDATION OR AT A MONOLITHIC FOOTING. IN NO CASE SHALL THERE BE A BREAK OR A COLD JOINT IN THE GROUT OF A COLUMN EXCEPT AT 1 FOOT FROM THE TOP IN PREPARATION FOR INSTALLATION OF A CONCRETE LINTEL.
 - VI. METAL CONNECTORS AT THE TOP OF THE COLUMN FOR HOLDING WOOD BEAMS OR GIRDERS SHALL BE INSTALLED WITH THE MINIMUM EMBEDMENT OF THE ASSOCIATED FASTENER FOR THE CONNECTOR AS SHOWN IN THE PLANS.
 - B. WOOD COLUMNS
 - I. ALL LOAD BEARING WOOD COLUMNS SHALL BE A MINIMUM OF #2 GRADE PRESSURE TREATED WOOD.
 - II. DIMENSIONAL WOOD COLUMNS OF 4 INCHES BY 4 INCHES IN CROSS SECTION SHALL BE ONLY BE USED FOR SUPPORTING OPEN WOOD DECKS WHERE THE FLOOR HEIGHT ABOVE THE FLOOR BELOW IS 8 FEET OR LESS. ALL OTHER DIMENSIONAL WOOD COLUMNS SHALL HAVE A MINIMUM CROSS SECTION OF A MINIMUM OF 6 INCHES BY 6 INCHES.
 - III. METAL CONNECTORS AT THE BASE AND THE TOP OF WOOD COLUMNS SHALL BE OF THE TYPE THAT RESISTS LATERAL LOADS AS WELL AS UPLIFT AND GRAVITY LOADS. IN NO CASE SHALL FLAT STRAPS BE USED UNLESS SPECIFICALLY SHOWN IN THE FRAMING PLANS OR CROSS SECTION DETAILS.

PLAN DATE	2-10-2014
-----------	-----------

DEEB FAMILY HOMES, LTD.
9400 RIVER CROSSING BLD.
NEW PORT RICHEY, FL 34655
727-376-6831



INVENTORY LOT 140 MAJESTIC OAKS PINELLAS COUNTY, FL.

LIBERTY CERT. THAT I HAVE REVIEWED THE ATTACHED DESIGN AS CORRECT WITH THE ULTIMATE RESPONSIBILITY FOR THE DESIGN BEING THAT OF THE REGISTERED PROFESSIONAL ENGINEER.
RICHARD W. RICHIEY, P.E.
NO. 16574
FL. 9200

ALLEN ENGINEERING & CONSTRUCTION SERVICES
RICHARD W. RICHIEY, P.E.
P.O. BOX 151
NEW PORT RICHEY, FL 34656
727-842-6100 Fax: 727-825-3973
richie@ape.com

C. COMPOSITE COLUMNS

I. A COMPOSITE COLUMN HERE IS DEFINED AS A HOLLOW COLUMN CONSISTING OF ANY MATERIAL SPECIFICALLY DESIGNED BY ITS MANUFACTURER TO BE LOAD BEARING. ANY OTHER TYPE OF HOLLOW COLUMN IS CONSIDERED AN ARCHITECTURAL FINISH INTENDED TO FIT OVER A STRUCTURAL COLUMN AND ITS USE AND DETAILS OF INSTALLATION ARE NOT THE RESPONSIBILITY OF THE STRUCTURAL ENGINEER.

II. LOAD BEARING COMPOSITE COLUMNS ARE A MANUFACTURED PRODUCT SUBJECT TO THE DESIGN AND LOAD BEARING CAPACITY DETERMINED BY THE MANUFACTURER. A SHOP DRAWING OR LETTER FOR THE INSTALLATION OF THE COLUMN SHALL BE PROVIDED BY THE STRUCTURAL ENGINEER TO SUPPLEMENT THE CONSTRUCTION PLANS AFTER THE SPECIFIC COLUMN AND MANUFACTURER HAVE BEEN IDENTIFIED.

III. IN ALL CASES, THE COLUMN MANUFACTURER'S INFORMATION SHALL BE PROVIDED TO THE STRUCTURAL ENGINEER BY THE CONTRACTING CLIENT OR HIS AGENT FOR REVIEW PRIOR TO ITS ACCEPTANCE FOR THE STRUCTURAL DESIGN. THIS INFORMATION SHALL INCLUDE THE LATERAL AS WELL AS UPLIFT AND GRAVITY, LOAD BEARING CAPACITIES.

D. STEEL TUBE COLUMNS

I. LOAD BEARING STEEL TUBE COLUMNS SHALL HAVE A MINIMUM WALL THICKNESS OF 1/4 INCH AND BE MADE OF STEEL WITH A DESIGN YIELD STRENGTH OF 46 KSI UNLESS OTHERWISE SHOWN IN THE STRUCTURAL DESIGN.

II. THE SPECIFIC CONNECTION SCHEME SHALL BE SHOWN IN THE STRUCTURAL DESIGN WHERE THE STEEL TUBE COLUMN IS TO BE INSTALLED.

E. ALUMINUM COLUMNS

I. LOAD BEARING ALUMINUM COLUMNS SHALL HAVE A MINIMUM WALL THICKNESS OF 1/4 INCH.

II. ALL FASTENERS AND CONNECTORS FOR ALUMINUM COLUMNS SHALL BE STAINLESS STEEL OR MONEL TO AVOID CORROSION DUE TO DISSIMILAR METALS BEING IN CONTACT.

III. THE SPECIFIC CONNECTION SCHEME SHALL BE SHOWN IN THE STRUCTURAL DESIGN WHERE THE ALUMINUM COLUMN IS TO BE INSTALLED.

24. ROOF

A. MANUFACTURED WOOD TRUSSES

I. THE MANUFACTURED ROOF TRUSS FRAMING PLAN CONTAINED HEREIN IS FOR THE SOLE PURPOSE OF ILLUSTRATING THE DESIGN INTENT AND FOR PLANNING TO BE USED BY THE TRUSS COMPONENT AND TRUSS SYSTEM ENGINEER OF THE TRUSS MANUFACTURER IN DEVELOPING THE ACTUAL ROOF TRUSS SYSTEM DESIGN. IT IS NOT TO BE USED FOR ANY OTHER PURPOSE AS IT IS SUBJECT TO ENGINEERING AND MAY BE DIFFERENT FROM THE FINAL DESIGN.

II. MANUFACTURED ROOF TRUSSES SHALL BE DESIGNED BY A LICENSED TRUSS COMPONENT AND TRUSS SYSTEM ENGINEER ACTING AS A DELEGATED ENGINEER AND WORKING THROUGH A TRUSS MANUFACTURER FOR THIS PURPOSE. THE SELECTION OF THE TRUSS MANUFACTURER IS HEREBY SUBORDINATED TO THE BUILDING CONTRACTOR.

III. THE TRUSS PLAN "SIGNED AND SEALED" BY THE DELEGATED ENGINEER SHALL BE PROVIDED TO AND PRIOR TO CONSTRUCTION OF THE UNDERLYING STRUCTURE AS THE STRUCTURAL ENGINEER RESERVES THE RIGHT TO MAKE STRUCTURAL CHANGES BASED UPON THE FINAL FLOOR TRUSS SYSTEM.

IV. THE TRUSS MANUFACTURER SHALL PROVIDE ALL LATERAL BRACING REQUIREMENTS TO THE BUILDING CONTRACTOR. IF NOT, THE BUILDING CONTRACTOR IS TO NOTIFY THE STRUCTURAL ENGINEER FOR GUIDANCE.

V. IN ADDITION TO THE METAL CONNECTORS SHOWN IN THE TRUSS LAYOUT OF THE ORIGINAL PLANS, EACH TRUSS IS TO BE SET ON WOOD FRAME BEARING WALLS OR SILL PLATES WITH 3-10D COMMON NAILS (TOE-NAILED).

VI. A MOISTURE BARRIER IS TO BE INSTALLED BETWEEN UNTREATED WOOD AND CONCRETE/MASONRY.

23.2. CONVENTIONAL FRAME

I. IN ADDITION TO THE METAL CONNECTORS SHOWN IN THE TRUSS LAYOUT OF THE ORIGINAL PLANS, EACH RAFTER IS TO BE SET ON WOOD FRAME BEARING WALLS OR SILL PLATES WITH 3-10D COMMON NAILS (TOE-NAILED).

II. ANY WOOD COMING IN CONTACT WITH MASONRY OR CONCRETE IS TO BE PRESSURE TREATED OR A MOISTURE

BARRIER IS TO BE INSTALLED BETWEEN UNTREATED WOOD AND CONCRETE OR MASONRY.

III. COLLAR TIES ARE TO BE INSTALLED BETWEEN RAFTERS AT 2/3 OF THE RIDGE HEIGHT FROM WHERE THE RAFTERS BEAR ON WALLS. THE COLLAR TIES ARE TO BE FASTENED WITH A MINIMUM OF 4-16D COMMON NAILS (CLINCHED) AT EACH LAP JOINT.

IV. EACH RAFTER IS TO BE ATTACHED TO THE RIDGE BEAM WITH A LIGHT ANGLE HANGER AS SHOWN IN THE FRAMING PLAN. IN ADDITION, A FLAT METAL STRAP SHALL BE INSTALLED ACROSS THE RIDGE BEAM TO TWO OPPOSING RAFTERS, REVIEWED BY THE STRUCTURAL ENGINEER FOR COMPLYING WITH THE DESIGN INTENT OF THE ORIGINAL PLAN AND FOR ANY CHANGES TO THE "TRUSS TO THE UNDERLYING STRUCTURE" CONNECTIONS.

V. AS PART OF THE REVIEW, THE STRUCTURAL ENGINEER WILL DETERMINE WHETHER THE TRUSS TO WALL/BEAM METAL CONNECTORS SHOWN IN THE ORIGINAL PLANS ARE ACCEPTABLE OR WHETHER THEY NEED TO BE CHANGED OR SUPPLEMENTED TO ACCOMMODATE THE LOADS SHOWN IN THE TRUSS COMPONENT SHEETS.

VI. THE STRUCTURAL ENGINEER IS NOT RESPONSIBLE FOR VERIFYING THE DIMENSIONAL, ARCHITECTURAL, OR FORM ASPECTS OF THE TRUSS MANUFACTURER'S PLAN WITH THE ORIGINAL PLANS.

VII. THE MINIMUM LIVE LOADS FOR THE ROOF TRUSS DESIGN IS TO BE BASED ON IBC 2010, SECTION 1607 FOR ROOF TYPE AND ROOFING MATERIAL.

VIII. THE DEAD LOADS ARE LISTED IN ITEM 16 ABOVE.

IX. ALL TRUSS TO TRUSS AND TRUSS TO GIRDER CONNECTORS ARE TO BE SPECIFIED BY THE TRUSS MANUFACTURER, INCLUDING CONNECTORS FOR TRUSS TO MANUFACTURED BEAM (E.G., GLULAM OR MICROLAM) SPECIFIED BY THE TRUSS MANUFACTURER. A SPECIFIC HANGER MUST BE SELECTED AND IDENTIFIED ON THE SIGNED AND SEALED COMPONENT SHEETS FOR EACH LOCATION A HANGER IS REQUIRED IN THE TRUSS SYSTEM.

X. THE TRUSS PLAN SIGNED AND SEALED BY THE DELEGATED ENGINEER SHALL BE PROVIDED TO AND REVIEWED BY THE STRUCTURAL ENGINEER FOR COMPLYING WITH THE DESIGN INTENT OF THE ORIGINAL PLAN AND FOR ANY CHANGES

TO THE "TRUSS TO UNDERLYING STRUCTURE" CONNECTIONS. THIS PLAN MUST BE PROVIDED TO THE STRUCTURAL ENGINEER.

XI. A RIDGE BEAM TERMINATING AT A GABLE END SHALL BE SUPPORTED AS A MINIMUM BY A 3 STUD PACK COLUMN BEARING ON THE UNDERLYING WALL OR BEAM.

1. TREATED LUMBER - DBL 1 1/2 INCH BY A HEIGHT AS SHOWN IN THE PLANS. FOR CONCRETE OR MASONRY WALLS THE FASTENERS SHALL BE 5/8 INCH BY 5 1/2 INCH SIMPSON TITEN HD CONCRETE BOLTS

2. SLEEPERS SHALL BE FASTENED TO UNDERLYING ROOF TRUSSES OR RAFTERS (NOT SHEATHING) WITH A MINIMUM OF 2-3/8 INCH BY 3 1/2 INCH LAG BOLTS WITH WASHERS AT EACH TRUSS OR RAFTER INTERSECTION AND NO GREATER THAN 24 INCHES ON CENTER AND SHALL CONSIST OF DIMENSIONAL LUMBER 1 1/2 INCH THICK BY A WIDTH AS SHOWN IN THE PLANS.

3. USE 2 INCH BY 4 INCH BLOCKING ATTACHED BETWEEN UNDERLYING STUDS, TRUSSES OR RAFTERS WITH A MINIMUM OF 3 10D COMMON NAILS AT EACH END IN ORDER TO SATISFY THE ON CENTER SPACING FROM THE LEDGERS OR SLEEPERS.

C. BEAMS

I. BEAMS SUPPORTING ROOF TRUSSES OR RAFTERS ARE TO BE ATTACHED AS SPECIFIED IN THE ROOF FRAMING PLAN.

24. UNDER NO CIRCUMSTANCES ARE THERE TO BE BUTT JOINTS BETWEEN THE BEARING POINTS OF ANY PLY OF A MULTIPLE BEAM. THE PLIES ARE TO BE CONTINUOUS BETWEEN BEARING POINTS. ROOF

A. LEDGERS/SLEEPERS

1. LEDGERS/NAILERS SHALL BE FASTENED TO WOOD STUDS (NOT SHEATHING) WITH A MINIMUM OF 2-3/8 INCH BY 5 1/2 INCH LAG BOLTS WITH WASHERS AT EACH STUD INTERSECTION AND NO GREATER THAN 16 INCHES ON CENTER AND SHALL CONSIST OF PRESSURE

2. MULTIPLE BEAMS CONSISTING OF MANUFACTURED WOOD (E.G. GLULAM, MICROLAM) ARE TO HAVE THE INDIVIDUAL PLIES INTERCONNECTED AS REQUIRED BY THE MANUFACTURER'S SPECIFICATIONS.

3. MULTIPLE BEAMS CONSISTING OF DIMENSIONAL LUMBER ARE TO HAVE THE INDIVIDUAL PLIES INTERCONNECTED AS FOLLOWS:

2. FOR TWO PLY BEAMS - ONE ROW OF 10D GALVANIZED COMMON NAILS AT 6" O.C. ON EACH SIDE OF THE BEAM.

3. FOR THREE PLY BEAMS - TWO ROWS OF 16D GALVANIZED COMMON NAILS SPACED AT 6" O.C. (TOP AND BOTTOM) THROUGH EACH SIDE OF THE BEAM

4. FOR FOUR PLY BEAMS AND LARGER - TWO ROWS OF 1/2 INCH DIAMETER CARRIAGE BOLTS OR ALL THREAD ROD WITH NUTS AND WASHERS SPACED AT 12 INCHES ON CENTER 2 INCHES FROM THE TOP AND BOTTOM EDGES OF THE BEAM.

B. SHEATHING

1. O.S.B. SHEATHING

1. ROOF SHEATHING COVERED BY COMPOSITE ROOFING SHALL BE A MINIMUM OF 15/32 INCH THICK (NOMINAL) O.S.B. MANUFACTURED WITH EXTERIOR GLUE.

2. ROOF SHEATHING COVERED BY TILE SHALL BE A MINIMUM OF 5/8 INCH THICK (NOMINAL) MANUFACTURED WITH EXTERIOR GLUE

3. THE LONG SIDE OF THE SHEATHING SHALL BE INSTALLED PERPENDICULAR TO THE ROOF TRUSS SYSTEM

4. FASTENING SHALL BE 8D RING SHANK NAILS AT 4" O.C. BOUNDARY & EDGES & 6" O.C. IN THE FIELD WITH A SETBACK OF 5'-0" FROM ALL EDGES.

5. METAL "H" CLIPS OR SOLID WOOD BLOCKING SHALL BE USED AT ALL UNSUPPORTED BUTT JOINTS BETWEEN TRUSSES OR RAFTERS.

25. PRECAST CONCRETE LINTELS

A. PRECAST AND PRESTRESSED CONCRETE LINTELS SHALL BE MANUFACTURED BY CASTCRETE AND INSTALLED PER MANUFACTURER'S SPECIFICATIONS AND INSTRUCTIONS

B. THE SIZE OF THE LINTELS SHALL BE BASED ON THE SPAN AND LOAD. REFER TO THE ATTACHED LINTEL SCHEDULE UNLESS OTHERWISE SHOWN IN THE STRUCTURAL DESIGN FOR THE SPECIFIC LINTEL

C. LINTEL SCHEDULE UNLESS SHOWN ON PLANS:

I. SPAN UP TO 3' - 8F8-0B

II. SPAN 3' TO 6' - 8F8-0B

III. SPAN 6' TO >14' 8F16-1B/1T

D. THE MINIMUM SPECIFIED GROUT COMPRESSIVE STRENGTH TO BE USED FOR LINTELS IS 3,000 PSI

E. THE REINFORCING STEEL SHALL BE ASTM GRADE 60

26. FASTENERS / METAL CONNECTORS

A. ALL FASTENERS AND METAL CONNECTORS SHALL BE MANUFACTURED BY SIMPSON STRONG TIE AND INSTALLED PER THE MANUFACTURER'S SPECIFICATIONS AND INSTRUCTIONS

B. THESE FASTENERS DO NOT INCLUDE TYPICAL NAILS AND SCREWS WHICH MAY BE MANUFACTURED BY OTHERS.

C. FOLLOW ALL MANUFACTURER'S SPECIFICATIONS AND INSTRUCTIONS FOR ALL FASTENERS, METAL CONNECTORS, SCREWS, NAILS ETC THAT ARE IN CONTACT WITH PRESSURE TREATED LUMBER.

27. DIMENSIONAL LUMBER

A. ALL WOOD FOR LOAD BEARING WALLS SHALL BE SOUTHERN YELLOW PINE #2 OR BETTER GRADE AND STAMPED BY THE CERTIFYING AGENCY. IN ADDITION, ALL WOOD SHALL BE PRESSURE TREATED FOR INTERIOR OR EXTERIOR USE WHERE EXPOSED TO MOISTURE, PLACED WITHIN 12 INCHES OF SOIL OR IN CONTACT WITH MASONRY OR CONCRETE.

28. STRUCTURAL SHEATHING

A. ALL SHEATHING USED FOR EXTERIOR APPLICATIONS SHALL BE EXTERIOR GRADE AND ADA STAMPED VERIFYING ITS RATING.

29. MASONRY

A. CONCRETE MASONRY UNITS SHALL HAVE A MINIMUM COMPRESSIVE STRENGTH OF 1900 PSI

B. CONCRETE MASONRY UNITS SHALL CONFORM WITH AMERICAN CONCRETE INSTITUTE STANDARD 530.

C. MORTAR SHALL BE OF TYPE M OR S GRAY MORTAR

30. GROUT

A. ALL GROUT SHALL BE A FINE TYPE HAVING A MINIMUM COMPRESSIVE STRENGTH OF 3,000 PSI UNLESS SPECIFICALLY SHOWN OTHERWISE BY A MANUFACTURER PURSUANT TO GROUT USE WITH ITS PRODUCTS.

31. REINFORCING STEEL (GENERAL)

31.1. ALL REINFORCING STEEL SHALL BE ASTM GRADE 40 EXCEPT GRADE 60 SHALL BE USED FOR GRADE BEAMS, ALL LINTELS TYPES (E.G., PRECAST AND FIELD FORMED), AND



DEEB FAMILY HOMES, LTD. 9400 RIVER CROSSING BLD. NEW PORT RICHEY, FL 34655 727-376-6831

Table with 2 columns: PLAN DATE, 2-10-2014

INVENTORY LOT 40 MAJESTIC OAKS PINELLAS COUNTY, FL.

PROJECT CHECKED THAT I HAVE PREPARED THE ATTACHED DESIGN TO COMPLY WITH ALL APPLICABLE LOCAL, STATE AND FEDERAL REQUIREMENTS AND I AM A LICENSED PROFESSIONAL ENGINEER IN THE STATE OF FLORIDA. SIGNED: [Signature] DATE: 2/10/2014

ALLEN ENGINEERING & CONSTRUCTION SERVICES RICH ALLEN PROFESSIONAL ENGINEER P.E. # 56928 C.A. # 9542 P.O. BOX 351 NEW PORT RICHEY, FL 34656 727-842-6100 Fax: 727-825-5975 richallenpe@gmail.com

COLUMNS UNLESS OTHERWISE SHOWN IN THE STRUCTURAL PLANS.

32. STRUCTURAL STEEL AND CONNECTION ACCESSORY MATERIAL [GENERAL]:

32.1 I-BEAMS, FORMED STRUCTURAL STEEL, FLAT BAR OR PLATE SHALL BE ASTM GRADE A36 UNLESS STATED OTHERWISE.

32.2 ALL STRUCTURAL STEEL SHALL HAVE A MINIMUM OF TWO COATS OF PRIMER AND TWO COATS OF EPOXY AS A CORROSION PREVENTIVE. THE BUILDING CONTRACTOR MAY VARY FROM THIS SPECIFICATION WITH THE APPROVAL OF THE STRUCTURAL ENGINEER IF IT CAN BE DEMONSTRATED ANOTHER MEANS OF CORROSION CONTROL IS EQUALLY EFFECTIVE.

32.3 ALL WELDING OF STRUCTURAL STEEL SHALL BE MADE WITH E60/70 TYPE ELECTRODES. THE DEPTH AND LENGTH FOR THE WELD SHALL BE SPECIFIED IN THE STRUCTURAL DESIGN FOR THE SPECIFIC CONNECTION.

33. VENTILATION [GENERAL]

33.1 THE STRUCTURAL ENGINEER IS NOT RESPONSIBLE FOR DETERMINING VENTILATION REQUIREMENTS OF CRAWL SPACES, FLOORS, AND ATTICS NOR THE MEANS AND METHODS FOR IMPLEMENTING THESE REQUIREMENTS.

34. WATERPROOFING [GENERAL]:

34.1 ANY RENDERING OR NOTES OF WATERPROOFING MEASURES FOR BASEMENTS OR HALF-BASEMENTS SHOWN IN THESE PLANS WHERE A SPECIFIC CONSTRUCTION DETAIL IS NOT SHOWN IN THE STRUCTURAL DESIGN IS AN ARCHITECTURAL ILLUSTRATION ONLY AND IS NOT PART OF THE STRUCTURAL DESIGN OR THE RESPONSIBILITY OF THE STRUCTURAL ENGINEER.

34 CRICKETS ARE ASSOCIATED WITH ARCHITECTURAL FINISHES AND ARE NOT THE RESPONSIBILITY OF THE STRUCTURAL ENGINEER.

35. FIRE RESISTANT DESIGN [GENERAL]

35.1 FIRE RESISTANT DESIGN OF STRUCTURAL ELEMENTS SHALL BE INCIDENTAL TO THEIR STRUCTURAL DESIGN AND SHALL BE BASED ON UNDERWRITER'S LABORATORY OR GYPSUM ASSOCIATION DESIGN FOR FIRE RATED FLOOR, WALL, AND ROOF ASSEMBLIES.

36. FLOOD RESISTANT DESIGN [GENERAL]:

36.1 FLOOD RESISTANT DESIGN OF STRUCTURAL ELEMENTS SHALL BE INCIDENTAL TO THEIR STRUCTURAL DESIGN AND SHALL BE BASED ON THE REQUIREMENTS STATED IN TITLE 44 CFR SECTIONS 59 AND 60, AND ON THOSE OF THE INDIVIDUAL COMMUNITY RATING AGENCIES FOR THE GOVERNMENTAL JURISDICTION WHERE THE CONSTRUCTION IS TO BE DONE.

36.2 HOWEVER, THE STRUCTURAL ENGINEER IS NOT RESPONSIBLE FOR IDENTIFYING AND SHOWING ON THE PLANS THE FLOOD ZONE CATEGORY, BASE FLOOD ELEVATION, AND THE FLOOR AND STORY HEIGHTS OF THE BUILDING IN RELATION TO THE BASE FLOOD ELEVATION. THIS INFORMATION IS CONSIDERED ARCHITECTURAL AND SITE RELATED AND SHALL BE PROVIDED TO THE STRUCTURAL ENGINEER BY THE CONTRACTING CLIENT OR HIS AGENT. 2 WATERPROOFING MEASURES ABOVE GRADE (E.G., FLASHING, CAULKING, SHAPE, AND LOCATION OF

37. SPECIAL CONSTRUCTION [GENERAL]:

37.1 ALUMINUM STRUCTURAL ALUMINUM COLUMNS.

I. ANY ALUMINUM STRUCTURES SHOWN IN THESE PLANS SUCH AS PORCH AND POOL ENCLOSURES OR GUARDRAILS AND HANDRAILS ARE FOR ARCHITECTURAL ILLUSTRATION ONLY AND ARE NOT PART OF THE STRUCTURAL DESIGN OR THE RESPONSIBILITY OF THE STRUCTURAL ENGINEER.

II. WHERE THE ALUMINUM STRUCTURE ATTACHES TO THE MAIN STRUCTURE OR IS INCORPORATED IN THE MAIN STRUCTURE, SHOP DRAWINGS FOR THESE STRUCTURES SHALL BE PROVIDED TO THE STRUCTURAL ENGINEER TO DETERMINE THEIR EFFECT ON THE MAIN STRUCTURE.

37.2 SWIMMING POOLS

I. ANY SWIMMING POOLS OR HOT TUBS SHOWN IN THESE PLANS ARE FOR ARCHITECTURAL ILLUSTRATION ONLY AND ARE NOT PART OF THE STRUCTURAL DESIGN OR THE RESPONSIBILITY OF THE STRUCTURAL ENGINEER.

37.3 FENCES AND RETAINING WALLS

I. ANY RENDERINGS OF FENCES, RETAINING WALLS, OR EXTERIOR PLANTERS SHOWN IN THESE PLANS WHERE A SPECIFIC STRUCTURAL DETAIL IS NOT SHOWN FOR THEIR CONSTRUCTION ARE FOR ARCHITECTURAL ILLUSTRATION ONLY AND ARE NOT PART OF THE STRUCTURAL DESIGN OR THE RESPONSIBILITY OF THE STRUCTURAL ENGINEER.

37.4 DRIVEWAYS AND SIDEWALKS

I. ANY DRIVEWAYS OR SIDEWALKS SHOWN IN THESE PLANS ARE FOR ARCHITECTURAL ILLUSTRATION ONLY AND ARE NOT PART OF THE STRUCTURAL DESIGN OR THE RESPONSIBILITY OF THE STRUCTURAL ENGINEER. STRUCTURES OTHER THAN

Floor and Roof Live Loads		
Uninhabitable Attics:	20 psf	
Habitable Attics, Bedroom:	30 psf	
All Other Rooms:	40 psf	
Garage:	40 psf	
Roofs:	20 psf	
Wind Design Data		
Ultimate Wind Speed:	145 mph	
Nominal (Basic) Wind Speed:	112 mph	
Risk Category:	II	
Wind Exposure:	B	
Enclosure Classification:	Enclosed	
Internal Pressure Coefficient:	0.18 +/-	
Components and Cladding:		
Roofing Zone 1:	16.0 psf max.,	-20.7 psf min.
Roofing Zone 2:	16.0 psf max.,	-36.0 psf min.
Roofing Zone 3:	16.0 psf max.,	-53.2 psf min.
Roofing at Zone 2 Overhangs:		-42.1 psf min.
Roofing at Zone 3 Overhangs:		-70.8 psf min.
Stucco, Cladding, Doors and Windows:		
Zone 4:	22.6 psf max.,	-24.5 psf min.
Zone 5:	22.6 psf max.,	-30.2 psf min.
9' Wide O/H Dr.:	19.8 psf max.,	-22.4 psf min.
16' Wide O/H Dr.:	19.0 psf max.,	-21.2 psf min.
The Nominal Wind Speed was used to determine these Component and Cladding Pressures.		
All exterior glazed openings shall be protected from wind-borne debris as per Section 1609.1.2 of the 2010 Florida Building Code.		
Geotechnical Information		
Design Soil Load-Bearing Capacity:	2,000 psf	
Flood Design Data		
Flood Zone:	X	

Door and Window Openings					
No.	Description	Opening Width	Opening Height	Distance from Corners	Design Pressure Requirements
1	Entry Door - example	3	8	12	21.4 psf max., -23.3 psf min.
2	Sliding Glass Door - example	6	6.67	6	20.7 psf max., -23.2 psf min.
3	Fixed Glass Window - example	2	2	3	22.6 psf max., -30.2 psf min.
4	10 sqft zone 4	3	3.3	10	22.6 psf max., -24.3 psf min.
4	20 sqft zone 4	4	5	10	21.6 psf max., -23.3 psf min.
4	30 sqft zone 4	5	6	10	21.1 psf max., -23.0 psf min.
4	40 sqft zone 4	5	8	10	20.7 psf max., -22.6 psf min.
4	50 sqft zone 4	5	10	10	20.2 psf max., -22.1 psf min.
4	100 sqft zone 4	10	10	10	19.2 psf max., -21.2 psf min.
5	10 sqft zone 4	4	2.5	2	22.6 psf max., -30.2 psf min.
5	20 sqft zone 4	4	5	2	21.6 psf max., -28.2 psf min.
5	30 sqft zone 4	4	7.5	2	21.1 psf max., -27.3 psf min.
5	40 sqft zone 4	4	10	2	20.7 psf max., -26.4 psf min.
5	50 sqft zone 4	4	12.5	2	20.2 psf max., -25.5 psf min.
5	100 sqft zone 4	4	25	2	19.2 psf max., -23.3 psf min.

WIND LOAD DESIGN DATA

ASPEN 3503

AECS 14014

ALLEN ENGINEERING & CONSTRUCTION SERVICES
RICH ALLEN PROFESSIONAL ENGINEER
P.E. # 56920 C.A. # 9542
P.O. BOX 151
NEW PORT RICHEY, FL 34655
727-842-6100 Fax: 727-825-3073
richallenpe@gmail.com

I HEREBY CERTIFY THAT I HAVE PREPARED THE ATTACHED DESIGN TO COMPLY WITH ALL APPLICABLE BUILDING CODES AND THAT I AM IN COMPLIANCE WITH SECTION 905 OF THE 2010 FLORIDA RESIDENTIAL BUILDING CODE. I HAVE SEALED FOR MY SIGNATURE AND DATE.
RICHARD P. ALLEN P.E. # 14020

INVENTORY LOT 4 MAJESTIC OAKS PINELLAS COUNTY, FL.

PLAN DATE
2-10-2014

DEEB FAMILY HOMES, LTD.
9400 RIVER CROSSING BLD.
NEW PORT RICHEY, FL 34655
727-376-6831

S4

TERMITE SPECIFICATIONS

INSTALL "BORACARE" TERMITE PROTECTION SYSTEM PER MANUF. SPECIFICATIONS

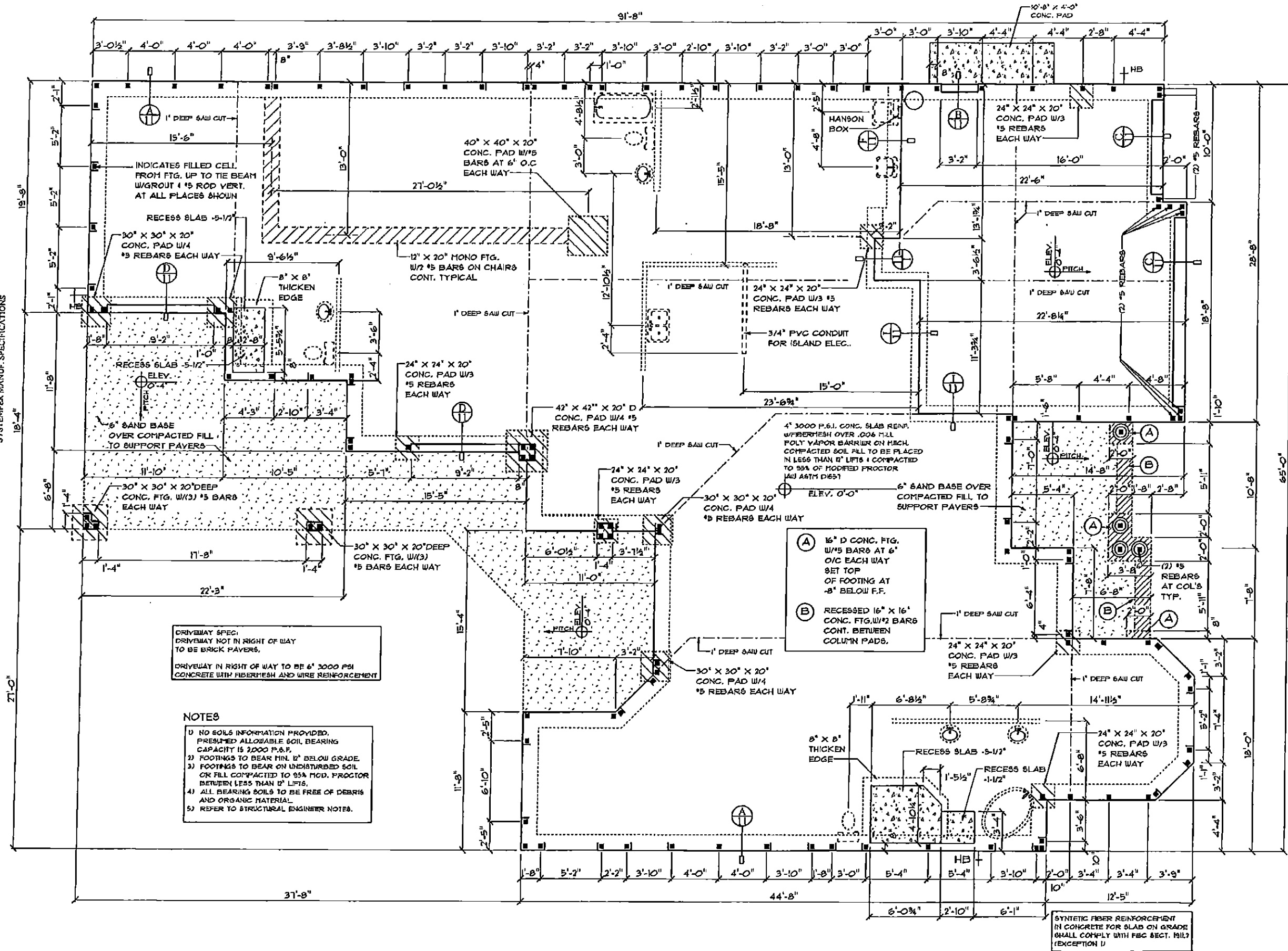

FOUNDATION PLAN

1/8" = 1'-0"

A.E.C.S. #14014

ASPEN 3503

DEEB FAMILY HOMES, LTD.
 9400 RIVER CROSSING BLD.
 NEW PORT RICHEY, FL 34655

PLAN DATE
01-20-2014
01-27-2014
02-10-2014

LOT#C MAJESTIC OAKS

THESEY CERTIFY THAT I HAVE PERFORMED THE ATTACHED DESIGN WORK IN ACCORDANCE WITH THE PROFESSIONAL ENGINEERING ACT IN COMPLIANCE WITH CHAPTER 48 OF THE 2016 FLORIDA BUILDING CODE. I AM A LICENSED PROFESSIONAL ENGINEER IN THE STATE OF FLORIDA. I HAVE REVIEWED AND APPROVED THE DESIGN. I HAVE NOTED ANY CHANGES TO THE ORIGINAL DESIGN. I HAVE NOTED ANY CHANGES TO THE ORIGINAL DESIGN.

ALLEN ENGINEERING & CONSTRUCTION SERVICES
 RICH ALLEN PROFESSIONAL ENGINEER
 P.L.E. #56920 C.A. #1542
 P.O. BOX 331
 NEW PORT RICHEY, FL 34656
 727-442-6100
 richallenpe@gmail.com

1

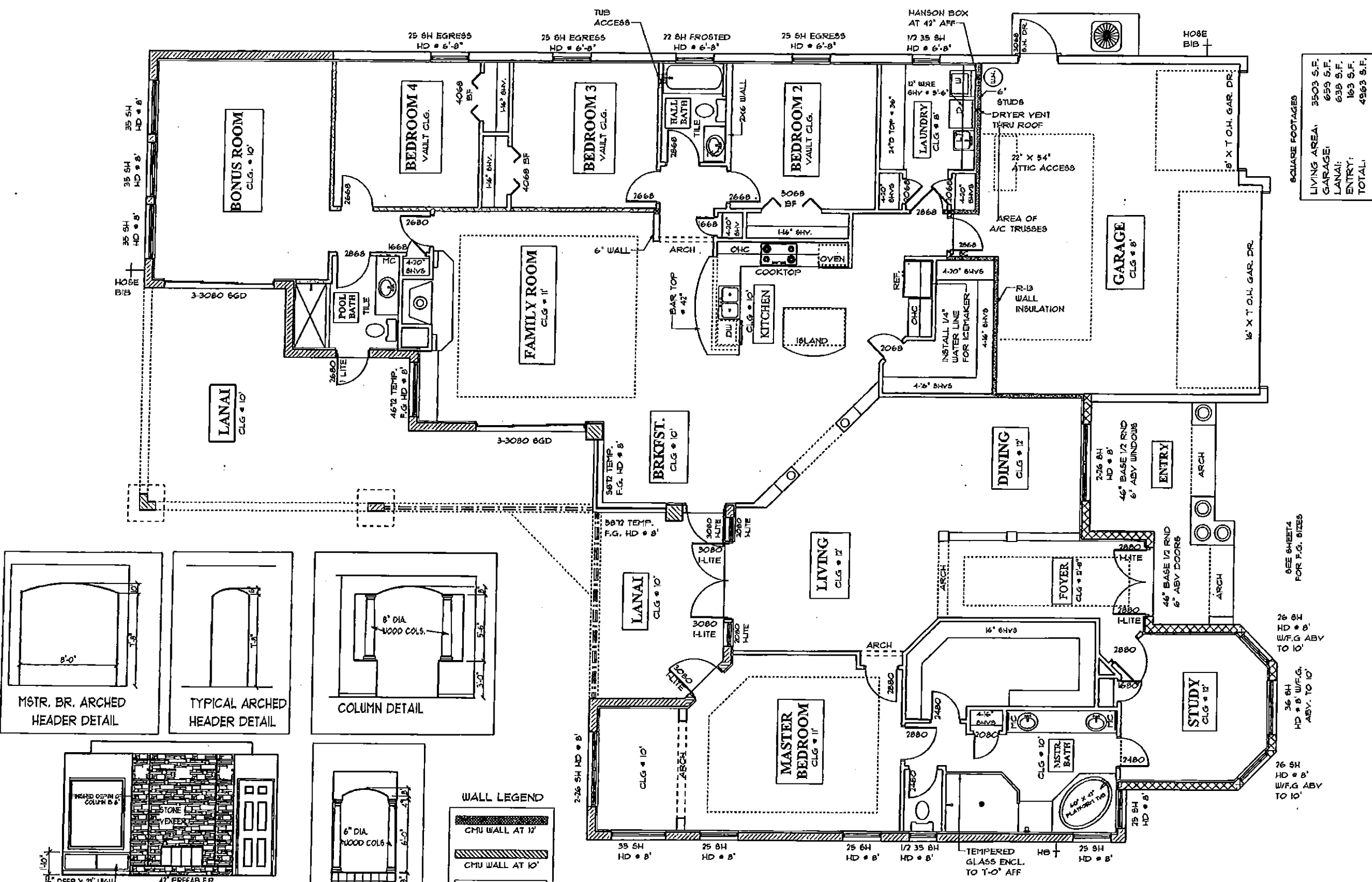

SQUARE FOOTAGES

LIVING AREA:	3503 S.F.
GARAGE:	659 S.F.
LANAI:	639 S.F.
ENTRY:	163 S.F.
TOTAL:	4963 S.F.

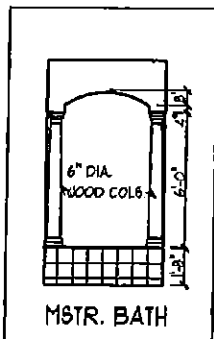
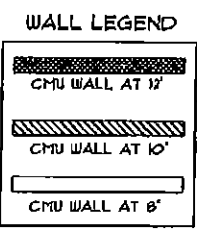
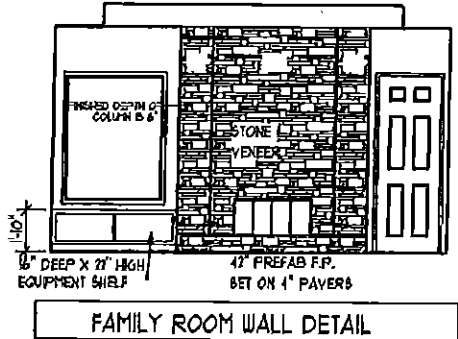
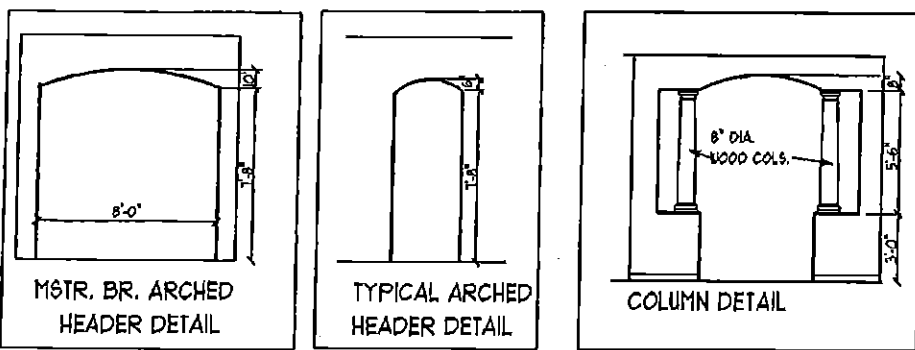

ASPEN 3503

A.E.C.S. #14014

1/8" = 1'-0"

FLOOR PLAN NOTES

LOT 4 MAJESTIC OAKS

PLAN DATE

01-20-2014
01-27-2014
02-10-2014

DEEB FAMILY HOMES, LTD.
 9400 RIVER CROSSING BLD.
 NEW PORT RICHEY, FL 34655

2

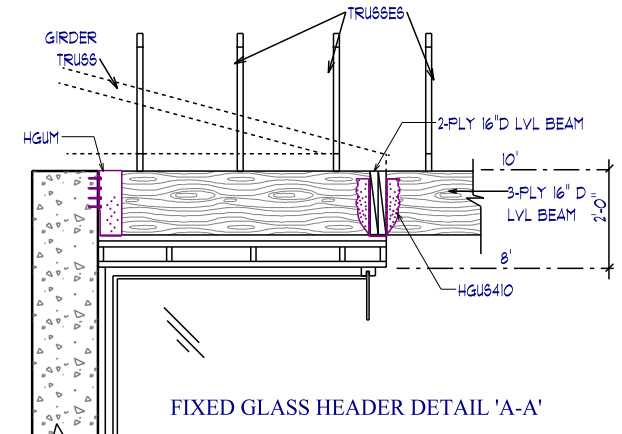
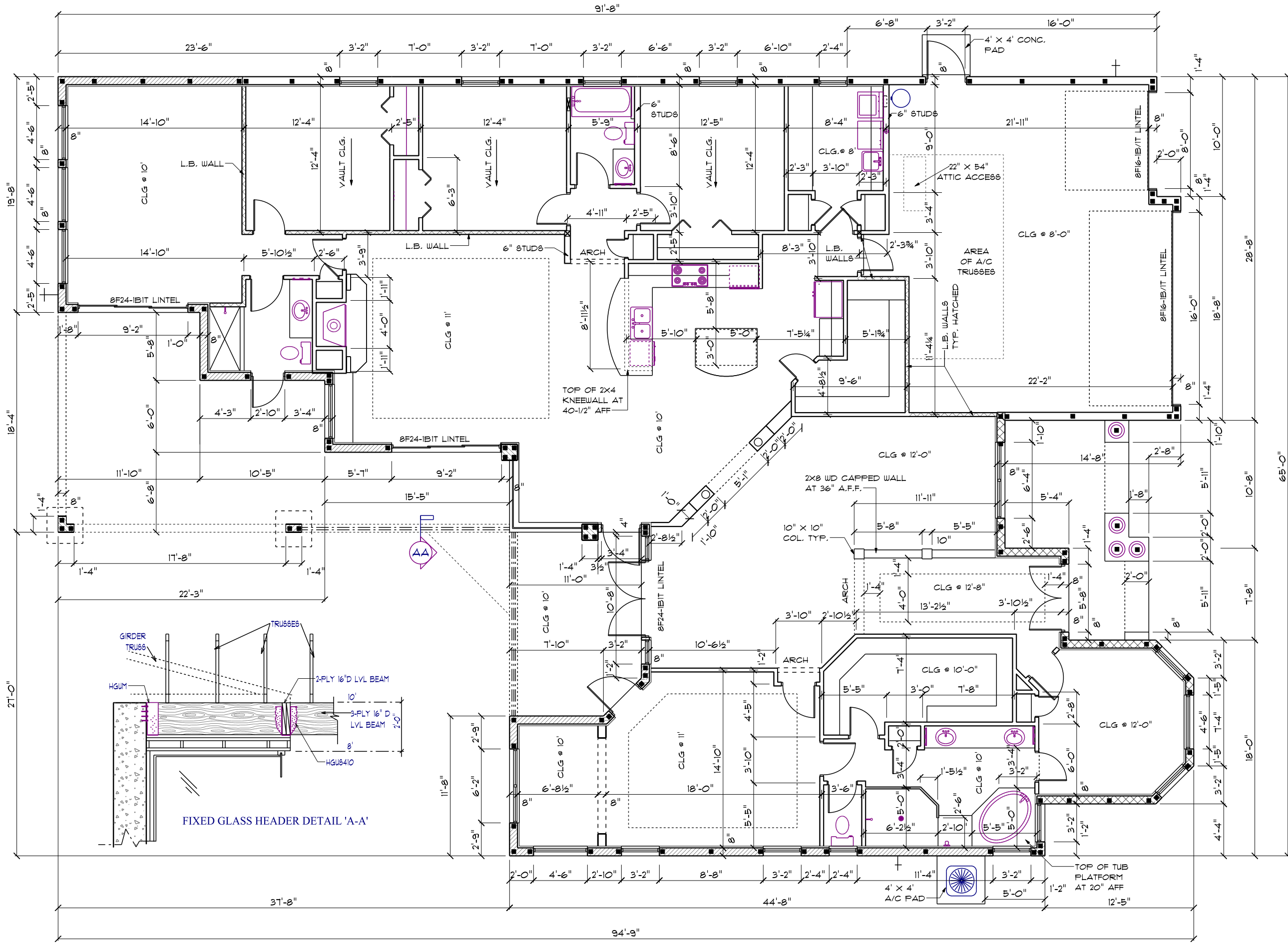

DIMENSION PLAN

DEEB FAMILY HOMES, LTD.
 9400 RIVER CROSSING BLD.
 NEW PORT RICHEY, FL. 34655

PLAN DATE
01-20-2014
01-27-2014
02-10-2014
02-27-2014

LOT 40 MAJESTIC OAKS

1/8" = 1'-0"

A.E.C.S. #14014

ASPEN 3503

HEREBY CERTIFY THAT I HAVE PERFORMED THE ATTACHED DESIGN TO COMPLY WITH 145 MPH ULTIMATE WIND LOADS, EXPOSURE B AND IT IS IN COMPLIANCE WITH CHAPTER 16 OF THE 2010 FLORIDA BUILDING CODE. SEALED FOR THE STRUCTURE ONLY.

ALLEN ENGINEERING & CONSTRUCTION SERVICES
 RICH ALLEN PROFESSIONAL ENGINEER
 P.E. #56920 C.A. #9542
 P.O. BOX 351
 NEW PORT RICHEY, FL 34656
 727-842-6100
 richallenpe@gmail.com

3

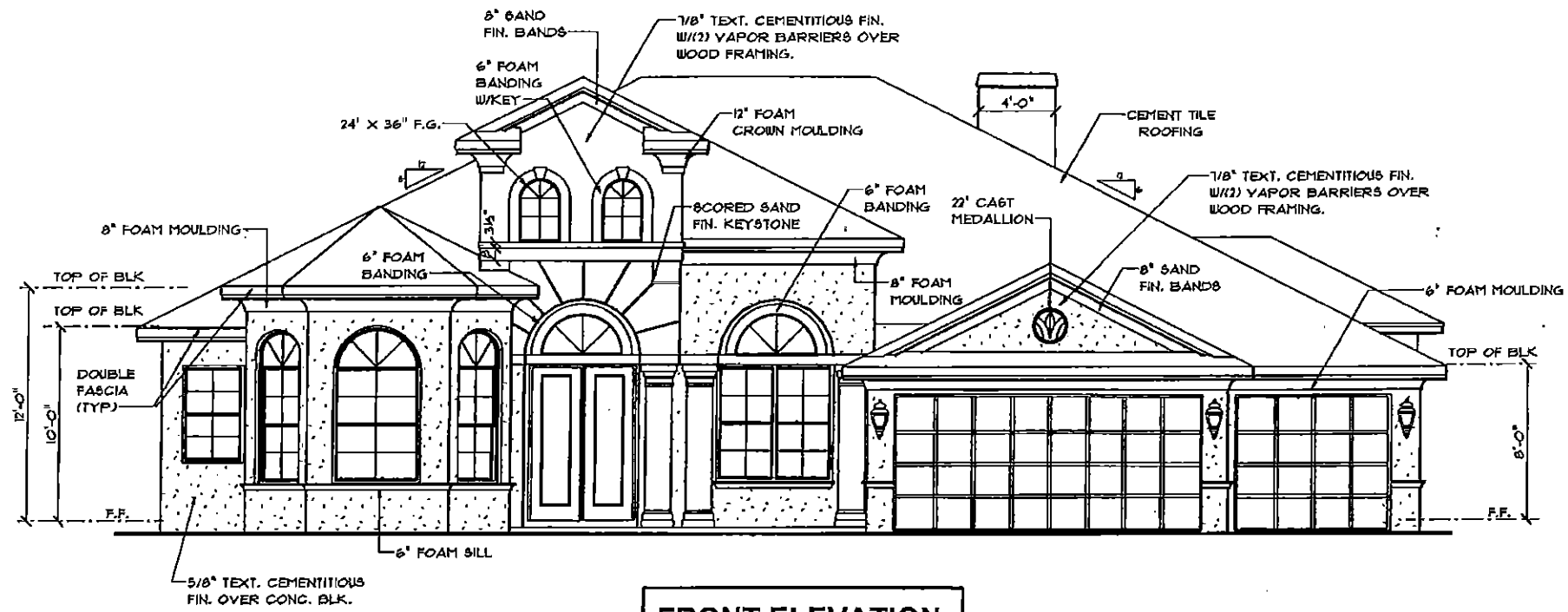

FRONT ELEVATION

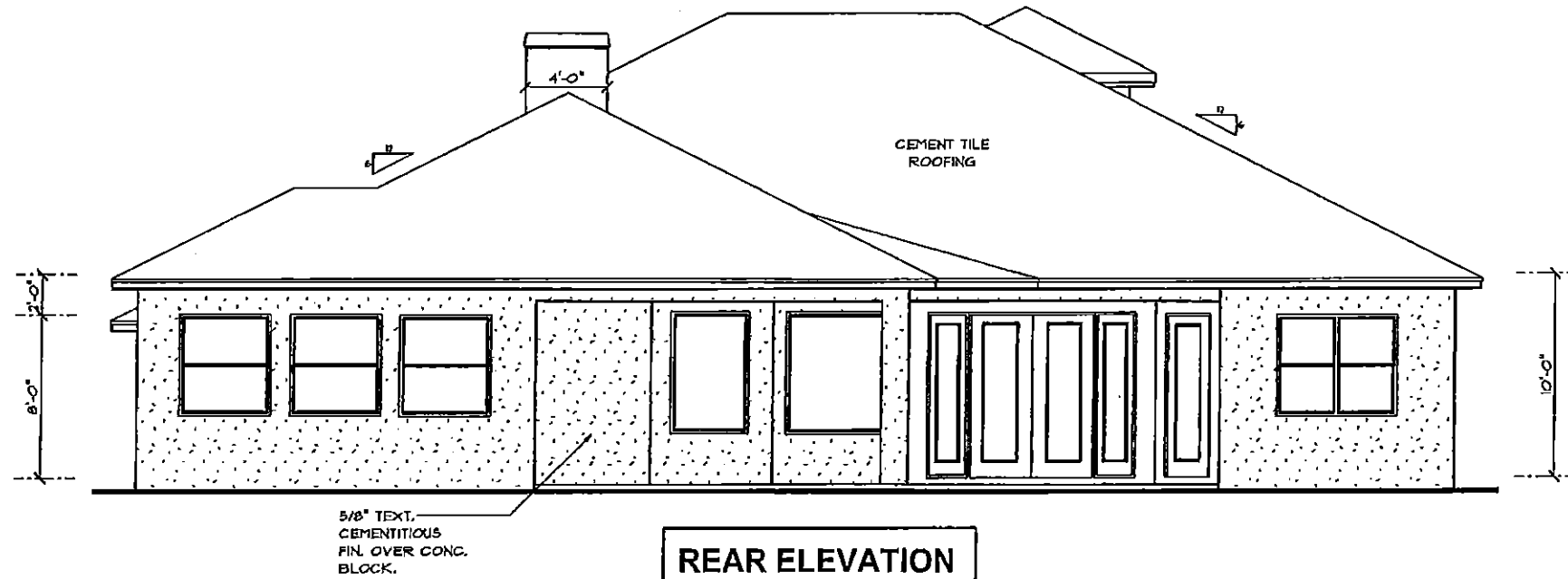

REAR ELEVATION

EXTERIOR ELEVATIONS

ASPEN 3503

A.E.C.S. #14014

1/8" = 1'-0"

PLAN DATE
01-23-2014
01-27-2014
02-10-2014

DEEB FAMILY HOMES, LTD.
 9400 RIVER CROSSING BLD.
 NEW PORT RICHEY, FL 34655

4

LOT 40 MAJESTIC OAKS

I HEREBY CERTIFY THAT I HAVE PERFORMED THE ARCHITECTURAL DESIGN TO COMPLY WITH ALL APPLICABLE WIND LOADS, EXPOSURE B AND IT IS IN COMPLIANCE WITH CHAPTER 16 OF THE 2010 FLORIDA BUILDING CODE. SEaled FOR STRUCTURE ONLY.
 SIGNED: *[Signature]*
 RICHARD ALLEN P.E. #69278

ALLEN ENGINEERING & CONSTRUCTION SERVICES
 RICH ALLEN PROFESSIONAL ENGINEER
 P.E. #69278 C.A. #9542
 P.O. BOX 351
 NEW PORT RICHEY, FL 34656
 727-842-6100
 richallenpe@gmail.com

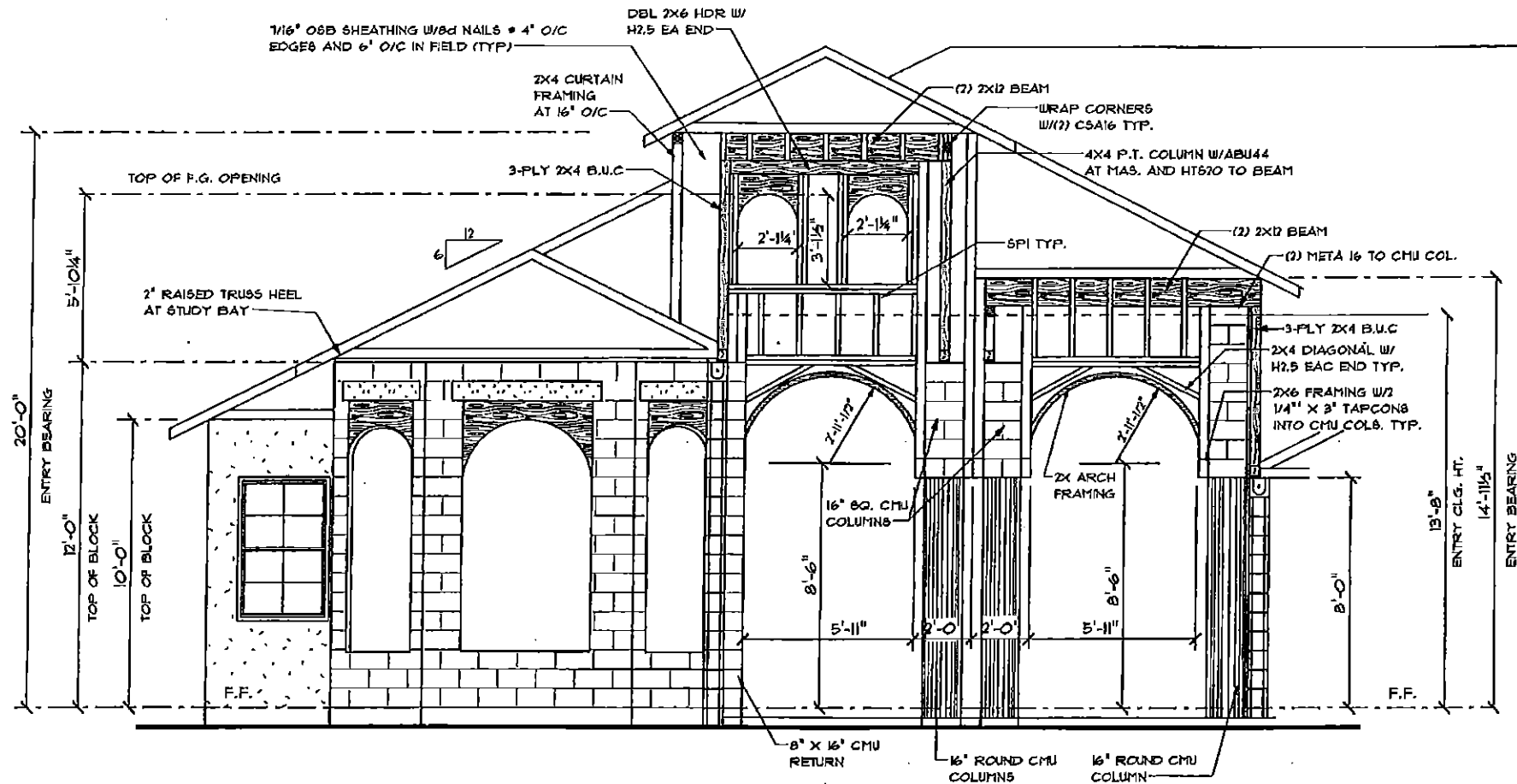

ENTRY FRAMING

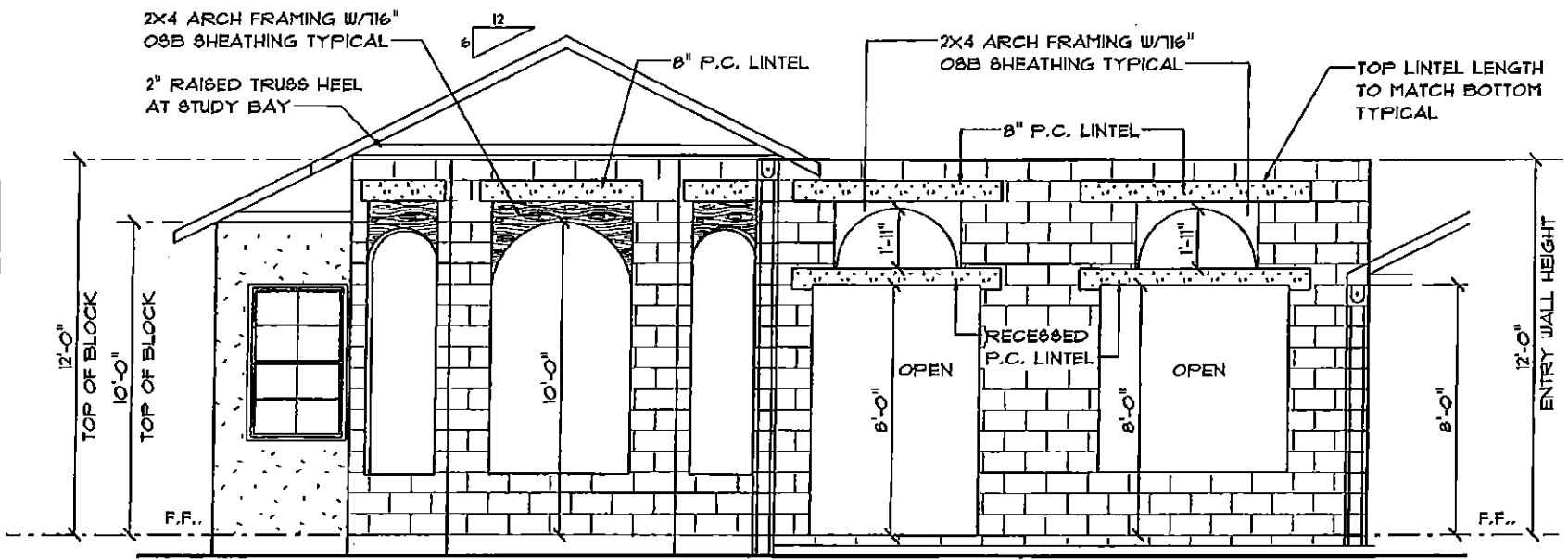

FRONT WALL CONST. ELEV.

NAILING SCHEDULE

SPI, 4-10d TO PLATE
6-10d TO STUD
H10, 8-8d X 1 1/2" TO TRUSS & TOP PLATE
H2, 5-8d
META16, 6-16d
CS16, 20-10d
HTS20, 20-10d
M1STAM36, 4-1/4" x 1 3/4" TAPCONS

NOTE: ALL NON STRUCTURAL LUMBER IS TO BE SOUTHERN PINE FIR U.N.O.

ENTRY TOWER DETAILS

3/16" = 1'-0"

A.E.C.S. #14014

ASPEN 3503

4A

DEEB FAMILY HOMES, LTD.
9400 RIVER CROSSING BLD.
NEW PORT RICHEY, FL. 34655

PLAN DATE
01-20-2014
01-27-2014
02-10-2014

LOT 40 MAJESTIC OAKS

I HEREBY CERTIFY THAT I HAVE PERFORMED THE ATTACHED DESIGN AND CALCULATIONS AND I AM A LICENSED PROFESSIONAL ENGINEER IN COMPLIANCE WITH CHAPTER 460F, THE 2010 FLORIDA BUILDING CODE, SEALED FOR ME BY THE STATE OF FLORIDA.
RICH ALLEN
P.E. #56920 C.A. 195542
NEW PORT RICHEY, FL. 34656
richallenpe@gmail.com

ALLEN ENGINEERING & CONSTRUCTION SERVICES
RICH ALLEN PROFESSIONAL ENGINEER
P.E. #56920 C.A. 195542
NEW PORT RICHEY, FL. 34656
richallenpe@gmail.com

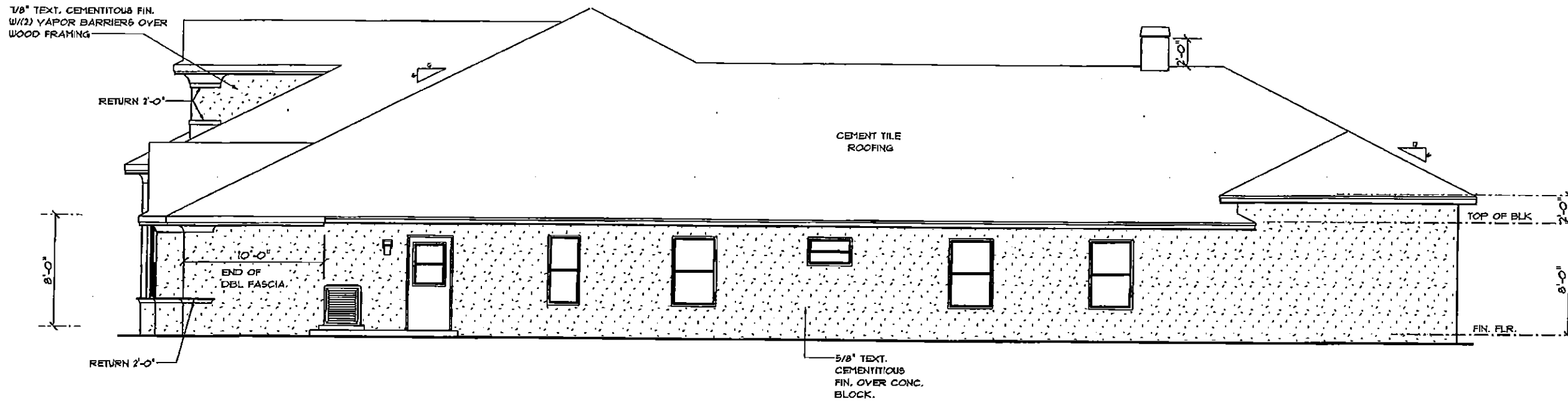

RIGHT ELEVATION

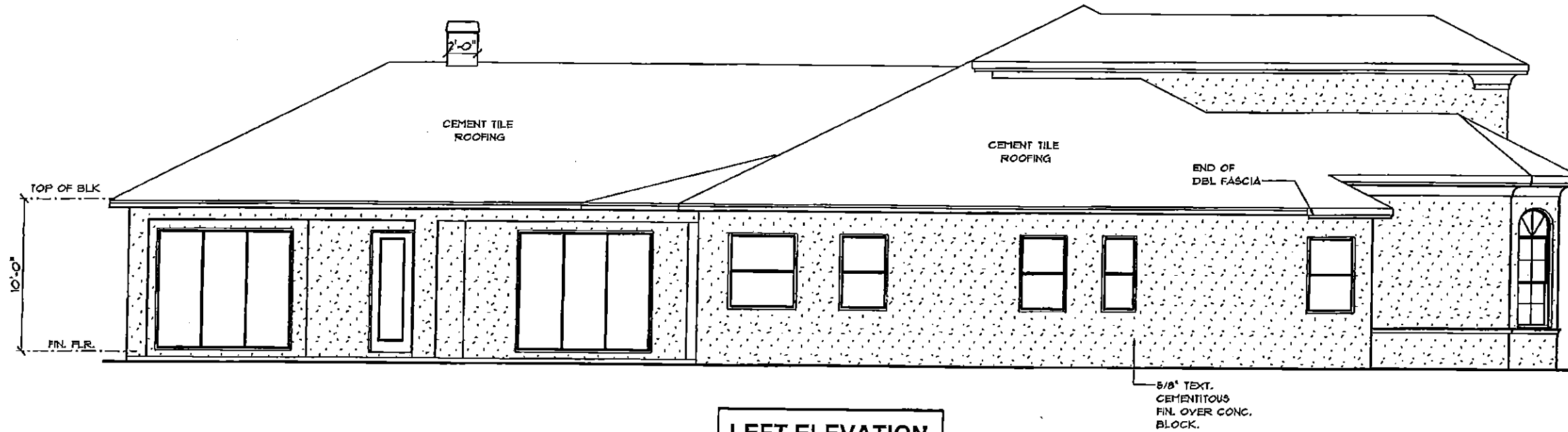

LEFT ELEVATION

EXTERIOR ELEVATIONS

1/8" = 1'-0"

A.E.C.S. #14014

ASPEN 3503

DEEB FAMILY HOMES, LTD.
 9400 RIVER CROSSING BLD.
 NEW PORT RICHEY, FL 34655

PLAN DATE
01-20-2014
01-27-2014
02-10-2014

LOT 40 MAJESTIC OAKS

I HEREBY CERTIFY THAT I HAVE PERFORMED THE ATTACHED DESIGN TO COMPLY WITH THE ULTIMATE WIND LOADS EXPOSURE AND IT IS IN COMPLIANCE WITH CHAPTER 16 OF THE FLORIDA BUILDING CODE. SIGNED: [Signature] REGISTERED PROFESSIONAL ENGINEER IN FLORIDA NO. 12548

ALLEN ENGINEERING & CONSTRUCTION SERVICES
 RICH ALLEN PROFESSIONAL ENGINEER
 P.E. #56926 C.A. 19542
 P.O. BOX 331
 NEW PORT RICHEY, FL 34656
 richallenpe@gmail.com

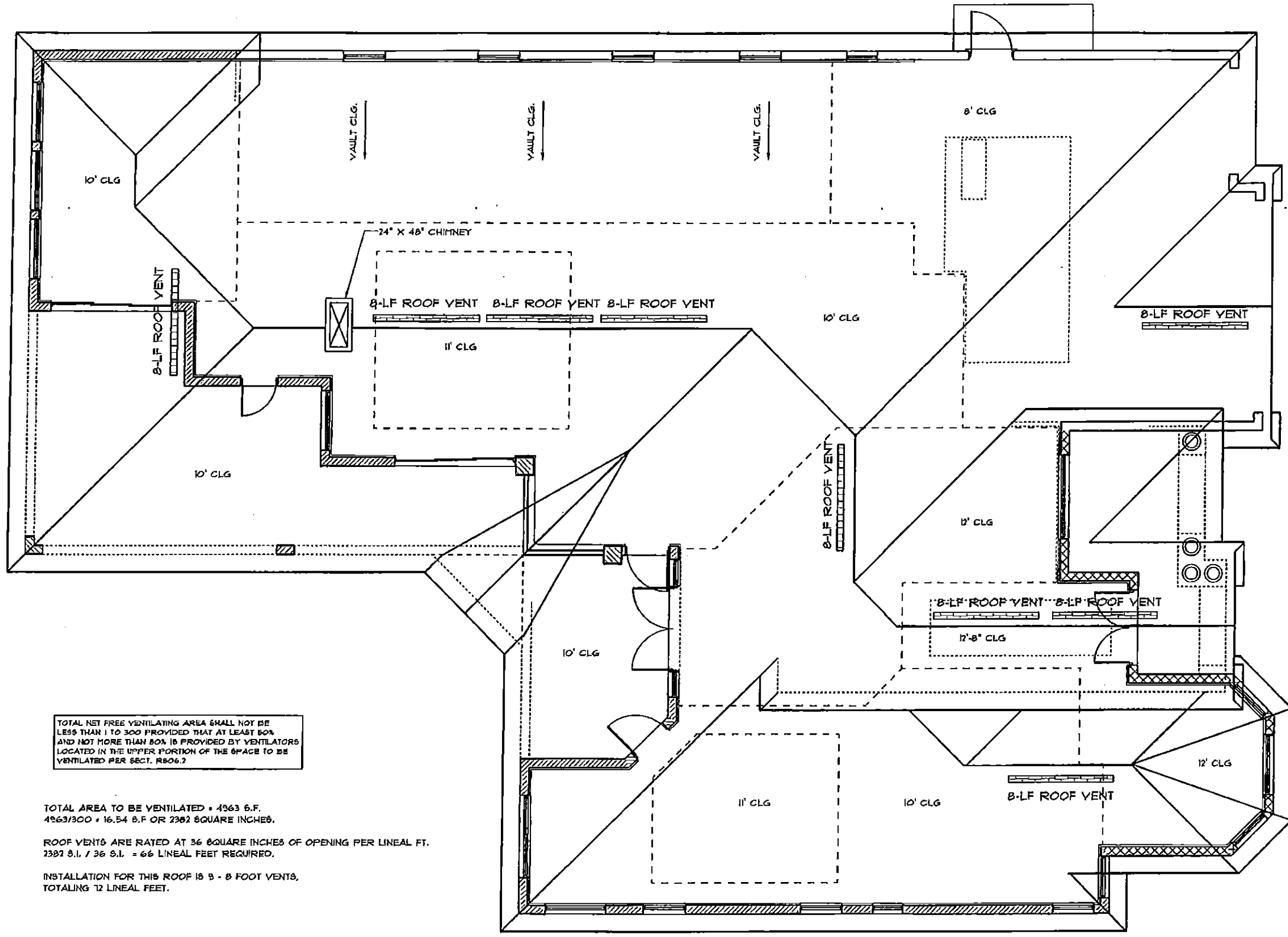

TOTAL NET FREE VENTILATING AREA SHALL NOT BE LESS THAN 1 TO 300 PROVIDED THAT AT LEAST 50% AND NOT MORE THAN 80% IS PROVIDED BY VENTILATORS LOCATED IN THE UPPER PORTION OF THE SPACE TO BE VENTILATED PER SECT. R806.2

TOTAL AREA TO BE VENTILATED = 4363 S.F.
 $4363/300 = 14.54$ S.F. OR 2382 SQUARE INCHES.

ROOF VENTS ARE RATED AT 36 SQUARE INCHES OF OPENING PER LINEAL FT.
 2382 S.I. / 36 S.I. = 66 LINEAL FEET REQUIRED.

INSTALLATION FOR THIS ROOF IS 9 - 8 FOOT VENTS, TOTALING 72 LINEAL FEET.

ROOF PLAN

ASPEN 3503

A.E.C.S. #14014

1/8" = 1'-0"

PLAN DATE
01-20-2014
01-27-2014
02-10-2014

DEEB FAMILY
 HOMES, LTD.
 9400 RIVER CROSSING BLD.
 NEW PORT RICHEY, FL 34655

6

LOT 40 MAJESTIC OAKS

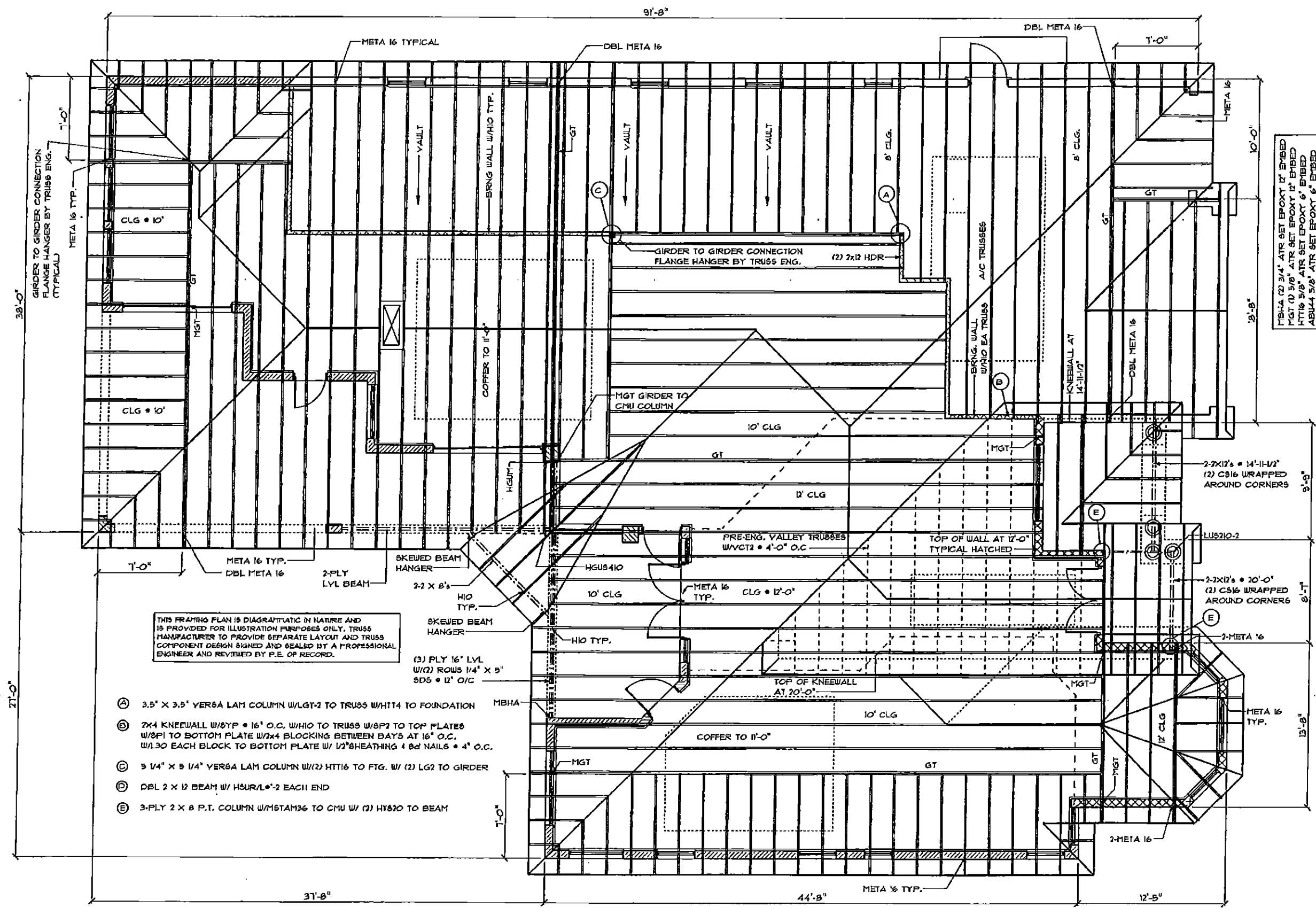

THIS FRAMING PLAN IS DIAGNOSTIC IN NATURE AND IS PROVIDED FOR ILLUSTRATION PURPOSES ONLY. TRUSS MANUFACTURER TO PROVIDE SEPARATE LAYOUT AND TRUSS COMPONENT DESIGN SIGNED AND SEALED BY A PROFESSIONAL ENGINEER AND REVIEWED BY P.E. OF RECORD.

- (A) 3.5' X 3.5' YERSA LAM COLUMN W/LGT-2 TO TRUSS W/HIT4 TO FOUNDATION
- (B) 2x4 KNEEWALL W/SYP • 16" O.C. W/HIO TO TRUSS W/SYP2 TO TOP PLATES W/SYP1 TO BOTTOM PLATE W/2x4 BLOCKING BETWEEN DAYS AT 16" O.C. W/1/30 EACH BLOCK TO BOTTOM PLATE W/ 1/2" SHEATHING & 8d NAILS • 4" O.C.
- (C) 3 1/4" X 5 1/4" YERSA LAM COLUMN W/1/2) HTT16 TO FTG. W/ (2) LG2 TO GIRDER
- (D) DBL 2 X 12 BEAM W/ HSUR/L•-2 EACH END
- (E) 3-PLY 2 X 8 P.T. COLUMN W/MSTAM36 TO CMU W/ (2) HTS20 TO BEAM

FISHA (2) 3/4" ATR 9ET EPOXY 17' EMBED
 MGT (2) 5/8" ATR 9ET EPOXY 12' EMBED
 HTT16 5/8" ATR 9ET EPOXY 6' EMBED
 ABU44 5/8" ATR 9ET EPOXY 6' EMBED

TRUSS PLAN

A.E.C.S. #14014 ASPEN 3503

PLAN DATE
01-20-2014
01-27-2014
02-10-2014

DEEB FAMILY HOMES, LTD.
 9400 RIVER CROSSING BLD.
 NEW PORT RICHEY, FL. 34655

6A

1/8" = 1'-0"
 LOT 40 MAJESTIC OAKS

ALLEN ENGINEERING & CONSTRUCTION SERVICES
 RICH ALLEN PROFESSIONAL ENGINEER
 P.E. #56920 C.A. #9542
 P.O. BOX 351
 NEW PORT RICHEY, FL. 34656
 727-842-6100
 richallenpe@gmail.com

ALLEN ENGINEERING & CONSTRUCTION SERVICES
 RICH ALLEN PROFESSIONAL ENGINEER
 P.E. #56920 C.A. #9542
 P.O. BOX 351
 NEW PORT RICHEY, FL. 34656
 727-842-6100
 richallenpe@gmail.com

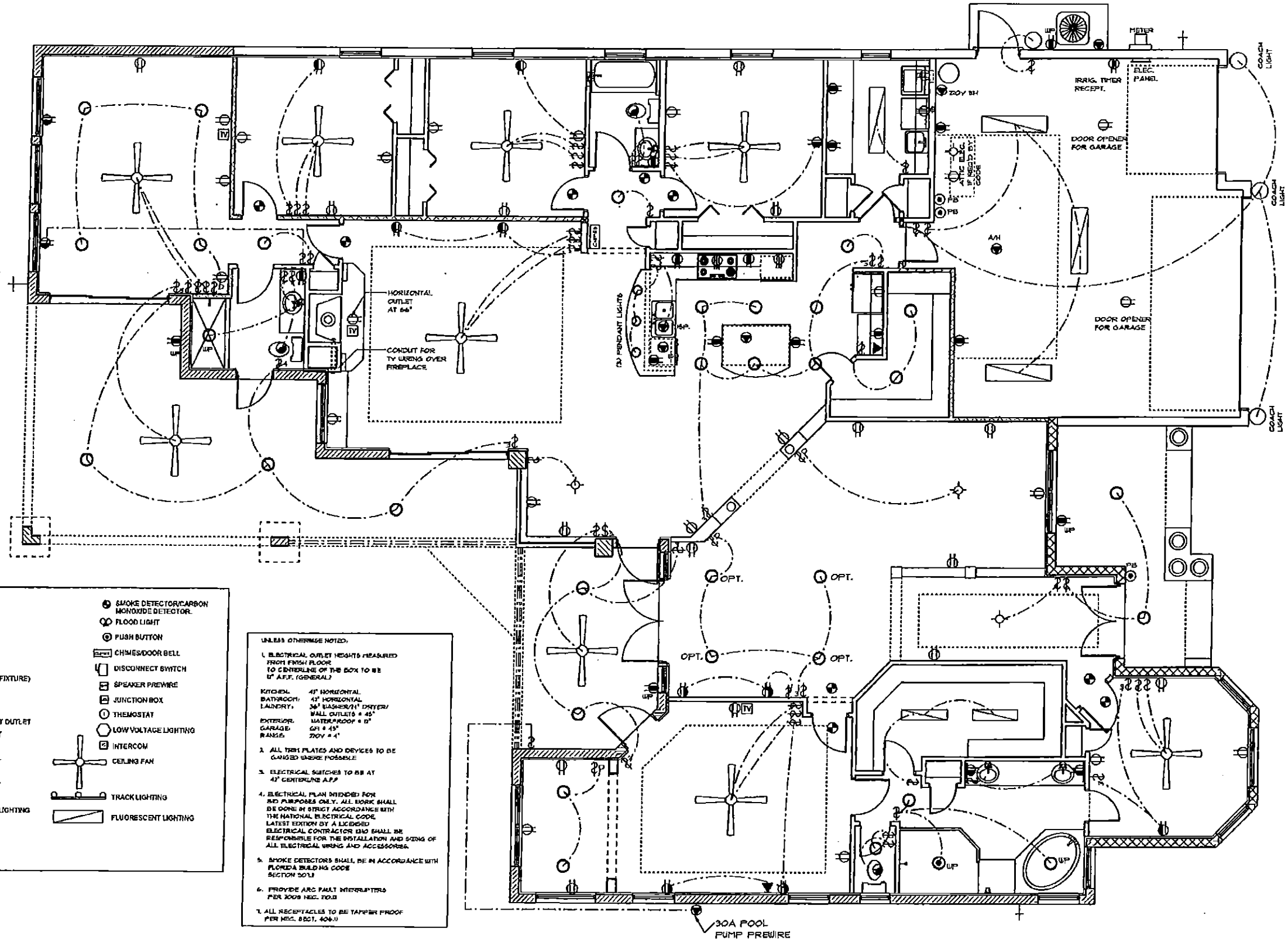

- ⌚ SINGLE POLE SWITCH
- ⌚⌚ DOUBLE POLE SWITCH
- ⌚⌚⌚ THREE WAY SWITCH
- ⌚⌚⌚⌚ FOUR WAY SWITCH
- ⌚⌚⌚⌚⌚ DIMMER SWITCH
- ⊙ CEILING FIXTURE
- ⊙ SCONES (WALL MOUNTED FIXTURE)
- ⊙ 110V DUPLEX OUTLET
- ⊙ SWITCHED OUTLET (1/2)
- ⊙ GROUND FAULT INTERRUPTER OUTLET
- ⊙ WATER PROOF GFI OUTLET
- ⊙ 220V OUTLET
- ⊙ SPECIAL SERVICES OUTLET
- ⊙ TV CABLE OUTLET
- ⊙ TELEPHONE CABLE OUTLET
- ⊙ RECESSED LIGHTING
- ⊙ WATER PROOF RECESSED LIGHTING
- ⊙ BATH FAN
- ⊙ BATH FAN WITH LIGHT
- ⊙ SMOKE DETECTOR/CARBON MONOXIDE DETECTOR
- ⊙ FLOOD LIGHT
- ⊙ PUSH BUTTON
- ⊙ CHIMES/DOOR BELL
- ⊙ DISCONNECT SWITCH
- ⊙ SPEAKER PREWIRE
- ⊙ JUNCTION BOX
- ⊙ THERMOSTAT
- ⊙ LOW VOLTAGE LIGHTING
- ⊙ INTERCOM
- ⊙ CEILING FAN
- ⊙ TRACK LIGHTING
- ⊙ FLUORESCENT LIGHTING

UNLESS OTHERWISE NOTED:

- ELECTRICAL OUTLET HEIGHTS MEASURED FROM FINISH FLOOR TO CENTERLINE OF THE BOX TO BE 1' A.F.F. (GENERAL)
- KITCHEN: 47" HORIZONTAL; BATHROOM: 47" HORIZONTAL; LAUNDRY: 36" WASHER/31" DRYER; WALL OUTLETS 4' 45"; EXTERIOR: WATERPROOF 4' 0"; GARAGE: GFI 4' 45"; RANGE: 200V 4'
- ALL TRIM PLATES AND DEVICES TO BE GANGED WHERE POSSIBLE.
- ELECTRICAL SWITCHES TO BE AT 47" CENTERLINE A.F.F.
- ELECTRICAL PLAN INTENDED FOR BID PURPOSES ONLY. ALL WORK SHALL BE DONE IN STRICT ACCORDANCE WITH THE NATIONAL ELECTRICAL CODE, LATEST EDITION BY A LICENSED ELECTRICAL CONTRACTOR WHO SHALL BE RESPONSIBLE FOR THE INSTALLATION AND SIZING OF ALL ELECTRICAL WIRING AND ACCESSORIES.
- SMOKE DETECTORS SHALL BE IN ACCORDANCE WITH FLORIDA BUILDING CODE SECTION 501.1
- PROVIDE ARC FAULT INTERRUPTERS PER 2008 NEC 210.12
- ALL RECEPTACLES TO BE TAMPER PROOF PER NEC 210.1, 404.11

ELECTRICAL PLAN

1/8" = 1'-0" A.E.C.S. #14014 ASPEN 3503

PLAN DATE

01-20-2014
01-22-2014
02-10-2014

DEEB FAMILY HOMES, LTD.
9400 RIVER CROSSING BLD.
NEW PORT RICHEY, FL 34655

LOT 46 MAJESTIC OAKS

7

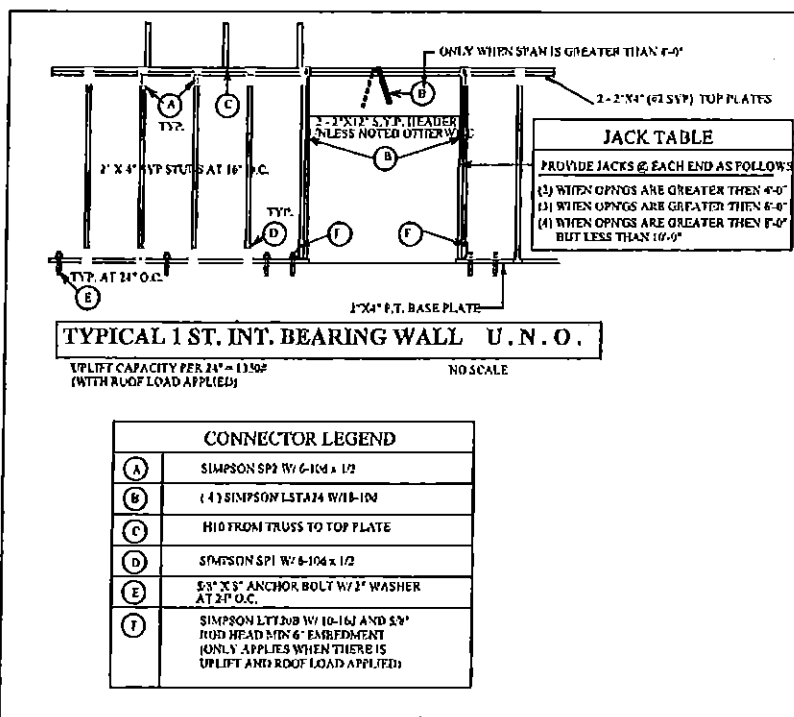
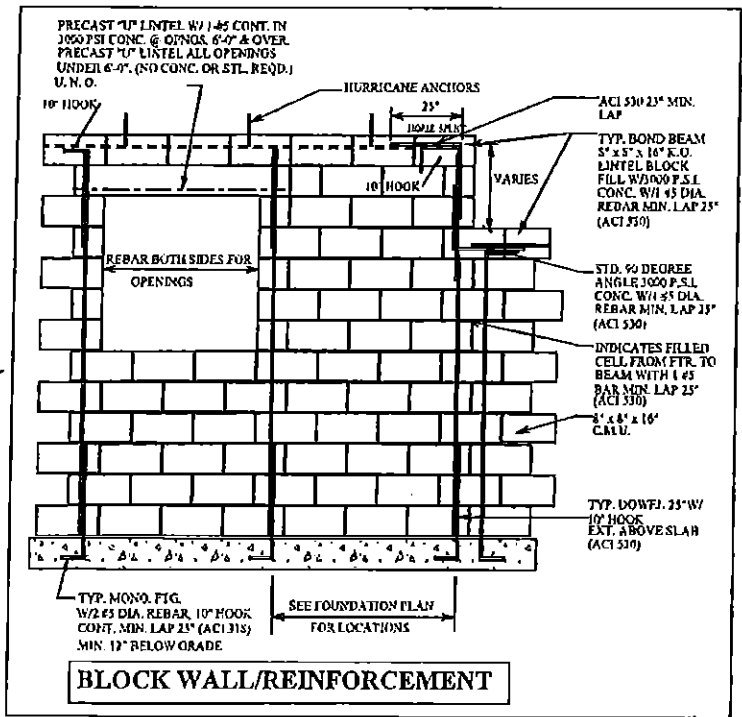
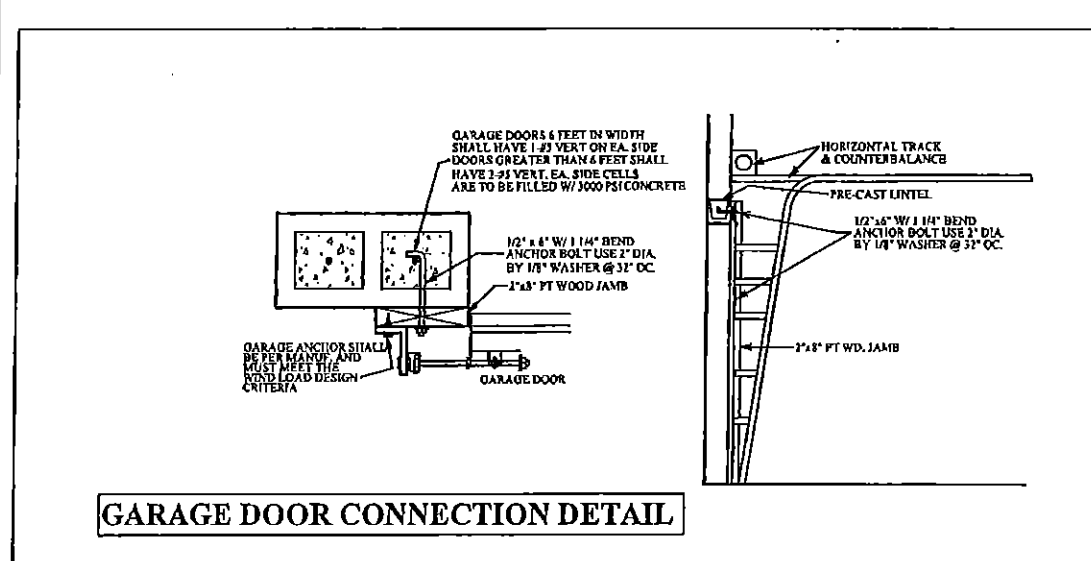
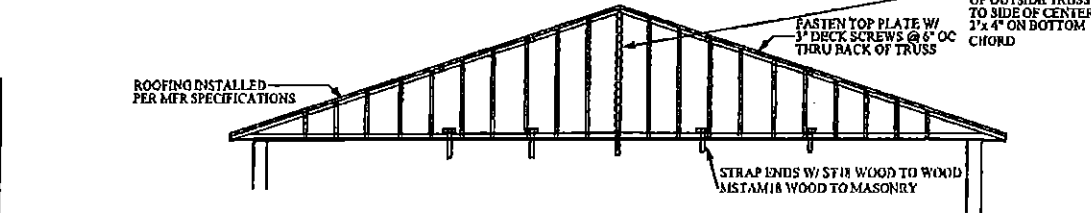
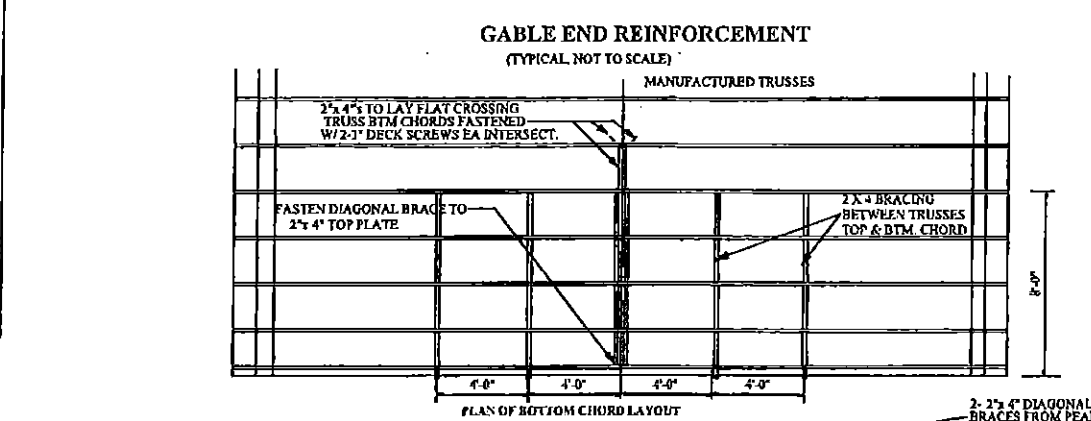
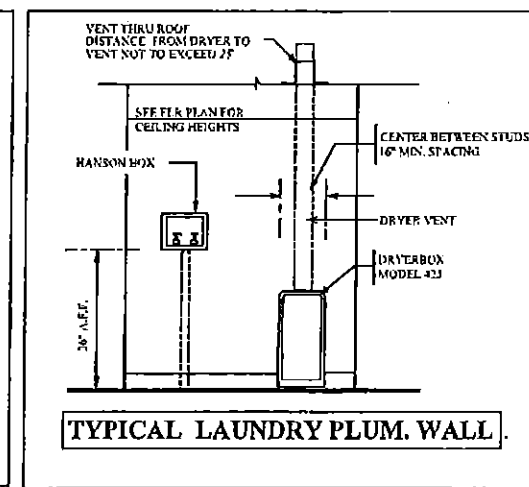
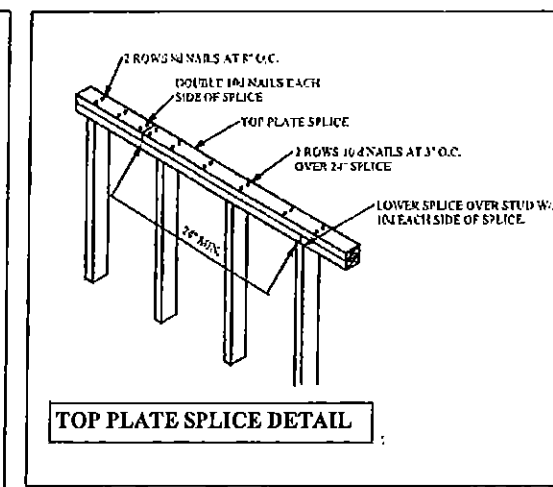
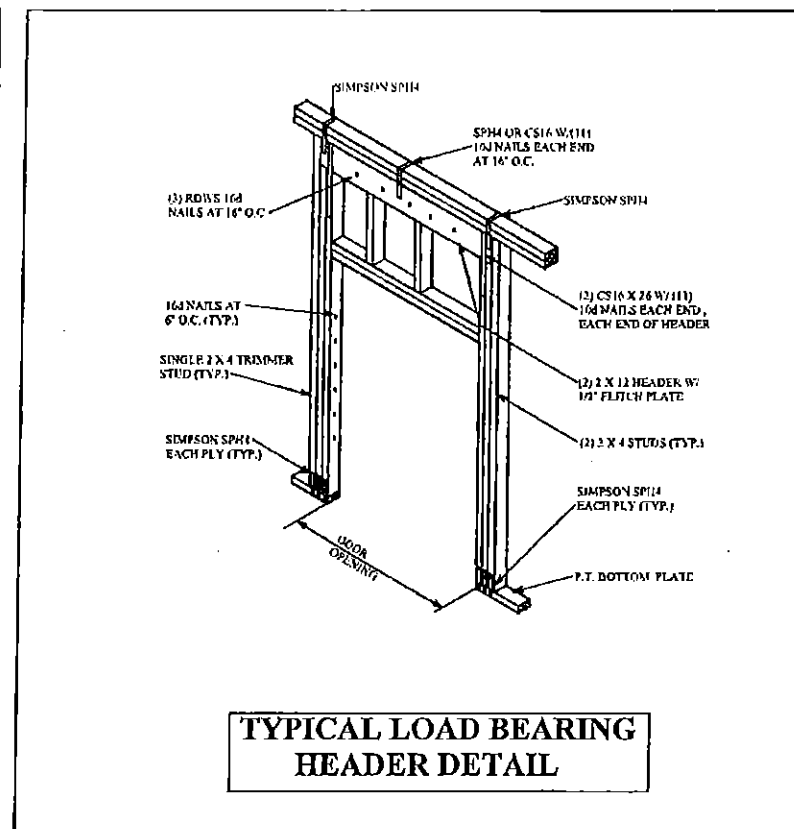
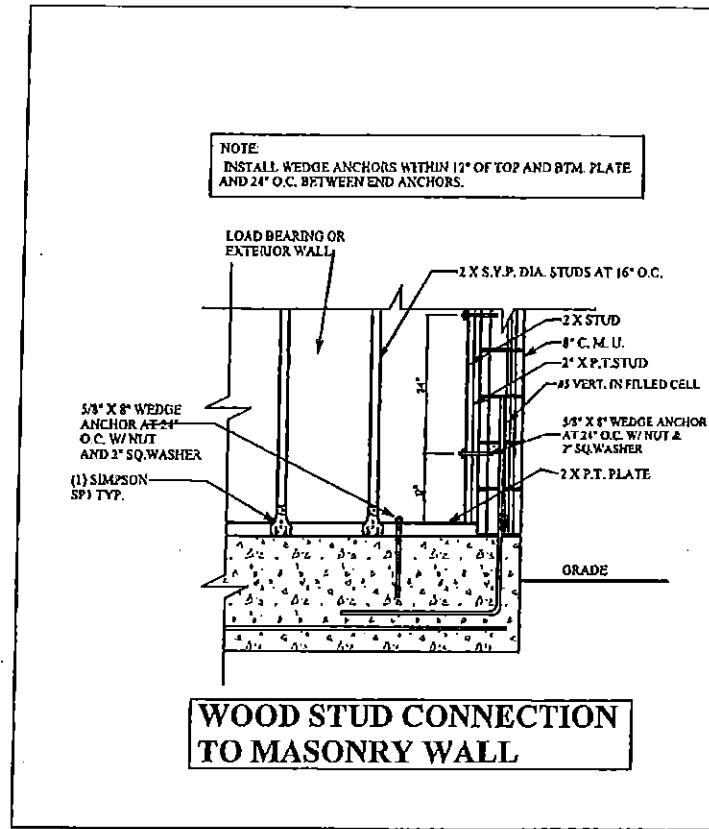

CONST. DETAILS

ASPEN 3503

ALLEN ENGINEERING & CONSTRUCTION SERVICES
RICH ALLEN PROFESSIONAL ENGINEER
P.E. # 56920 C.A. # 9542
P.O. BOX 151
NEW PORT RICHEY, FL 34656
727-842-6100 Fax: 727-825-3973
richallenpe@gmail.com

INVENTORY LOT 40 MAJESTIC OAKS PINELLAS COUNTY, FL.

PLAN DATE: 2-10-2014

DEEB FAMILY HOMES, LTD.
9400 RIVER CROSSING BLD.
NEW PORT RICHEY, FL 34655
727-376-6831

8

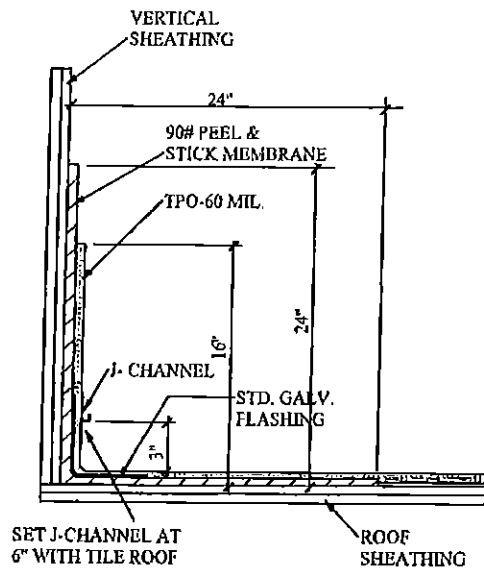

STD. FLASHING DETAIL

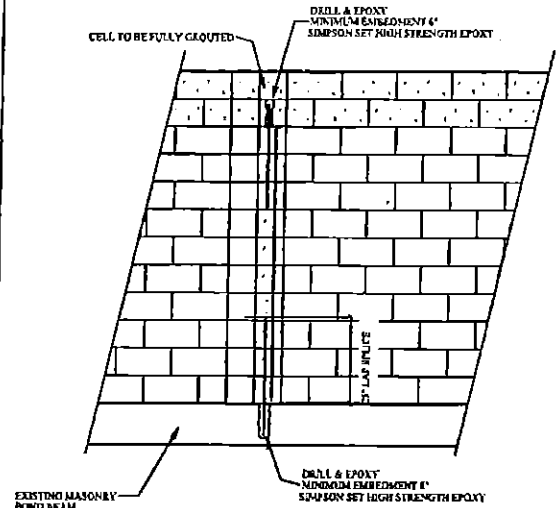

TYP. RETROFIT VERT. DOWEL CONDITION

NOTE: MISSING DOWELS: WHERE FOOTING DOWELS ARE PLACED INCORRECTLY OR MISTAKENLY ELIMINATED, REPLACE DOWEL AT PROPER LOCATION W/ GRADE 40 #5 BAR. INSTALL IN SLAB W/ 1\"/>

MISSING ANCHOR BOLTS AT BEARING WALL:

- EXTERIOR BEARING WALL:**
IN ADDITION TO THE GENERAL PLACEMENT REQUIREMENTS:
- 1) 5/8\"/>
- INTERIOR BEARING WALL:**
IN ADDITION TO THE GENERAL PLACEMENT REQUIREMENTS:
- 1) 5/8\"/>

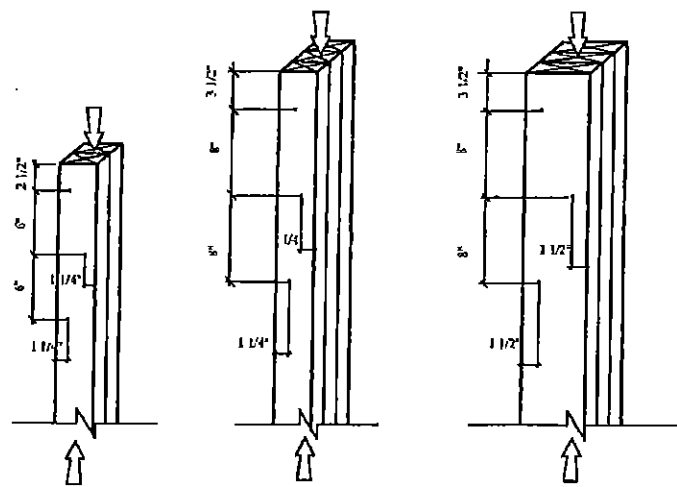

- (2) 2\"/>
- (3) 2\"/>
- (3) 2\"/>

- NOTES:
- 1) ADJACENT NAILS ARE DRIVEN FROM OPPOSITE SIDES OF THE COLUMN
 - 2) ALL NAILS PENETRATE AT LEAST 3/4 OF THE THICKNESS OF THE LAST LAMINATION
 - 3) EACH 304 COMMON NAIL MAY BE REPLACED W/ 2) 164 COMMON NAILS (ONE INTO EACH OUTSIDE FACE OF B.U.C. SAME NUMBER OF ROES, SAME SPACING)
 - 4) FOR 4 PLY, PROVIDE 1/4\"/>
 - 5) FOR 3-PLY, PROVIDE 1/4\"/>
 - 6) REFER TO NDS SECTION 13.3 FOR ADDITIONAL INFORMATION

TYP. NAILING SCHEDULE FOR BUILT-UP COLUMNS

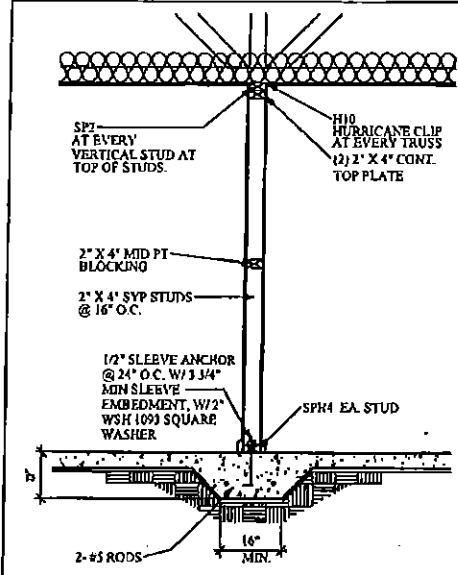

BEARING PARTITION

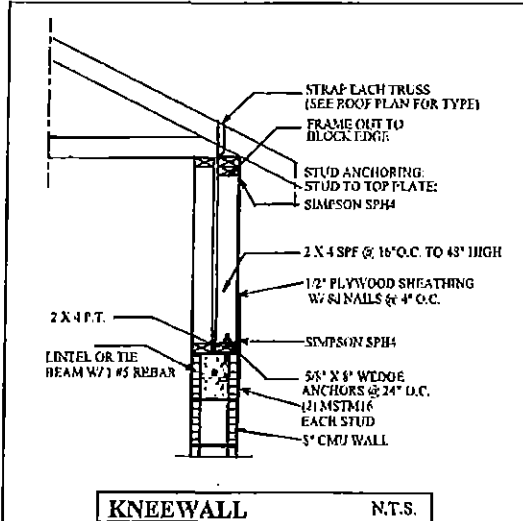

KNEEWALL N.T.S.

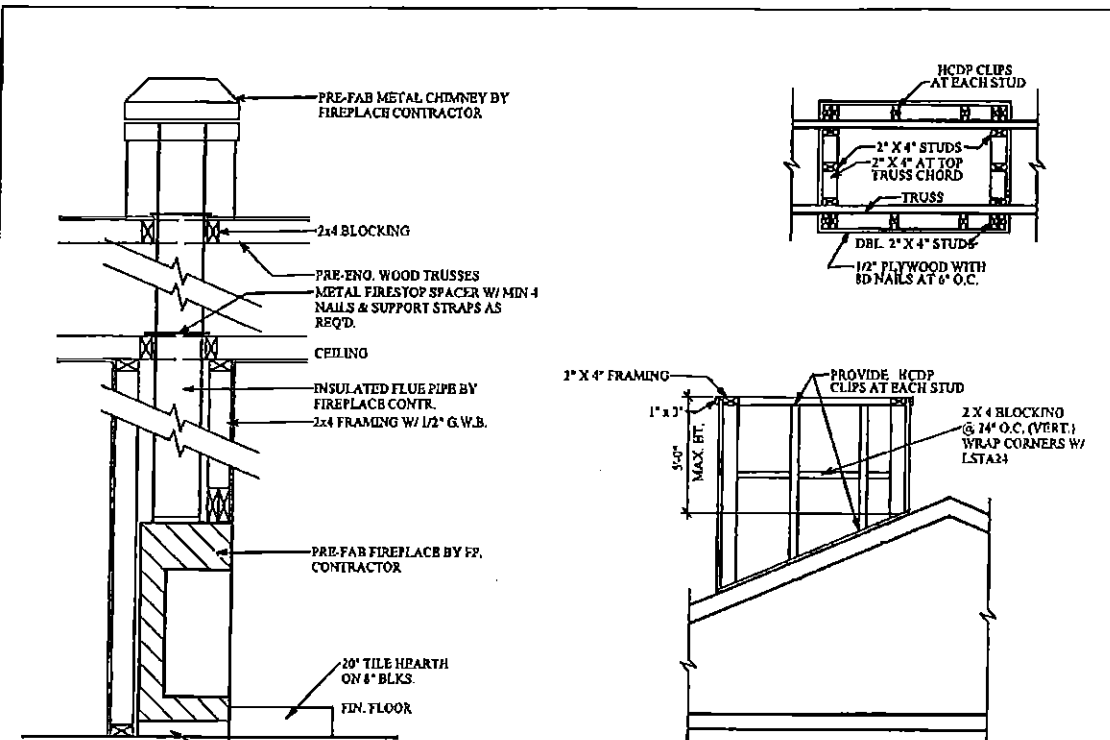

SECTION - FIREPLACE

DETAIL - CHIMNEY

ASPEN 3503

AECS 14014

CONST. DETAILS

ALLEN ENGINEERING & CONSTRUCTION SERVICES
RICH ALLEN PROFESSIONAL ENGINEER
P.E. # 56920 C.A. # 9562
P.O. BOX 351
NEW PORT RICHEY, FL. 34655
727-842-6100 Fax 727-825-5975
richallenpe@gmail.com

I HEREBY CERTIFY THAT I HAVE PERFORMED THE ATTACHED DESIGN TO COMPLY WITH ALL APPLICABLE CODES AND REGULATIONS AND I AM NOT PROVIDING ANY DESIGN OR CONSTRUCTION SERVICES TO ANY OTHER PROJECTS AT THE SAME TIME.
SEALER: [Signature]
RICH ALLEN P.E. # 56920

INVENTORY
LOT 40 MAJESTIC OAKS
PINELLAS COUNTY, FL.

PLAN DATE	2-10-2014
-----------	-----------

DEEB FAMILY HOMES, LTD.
9400 RIVER CROSSING BLD.
NEW PORT RICHEY, FL. 34655
727-376-6831

9

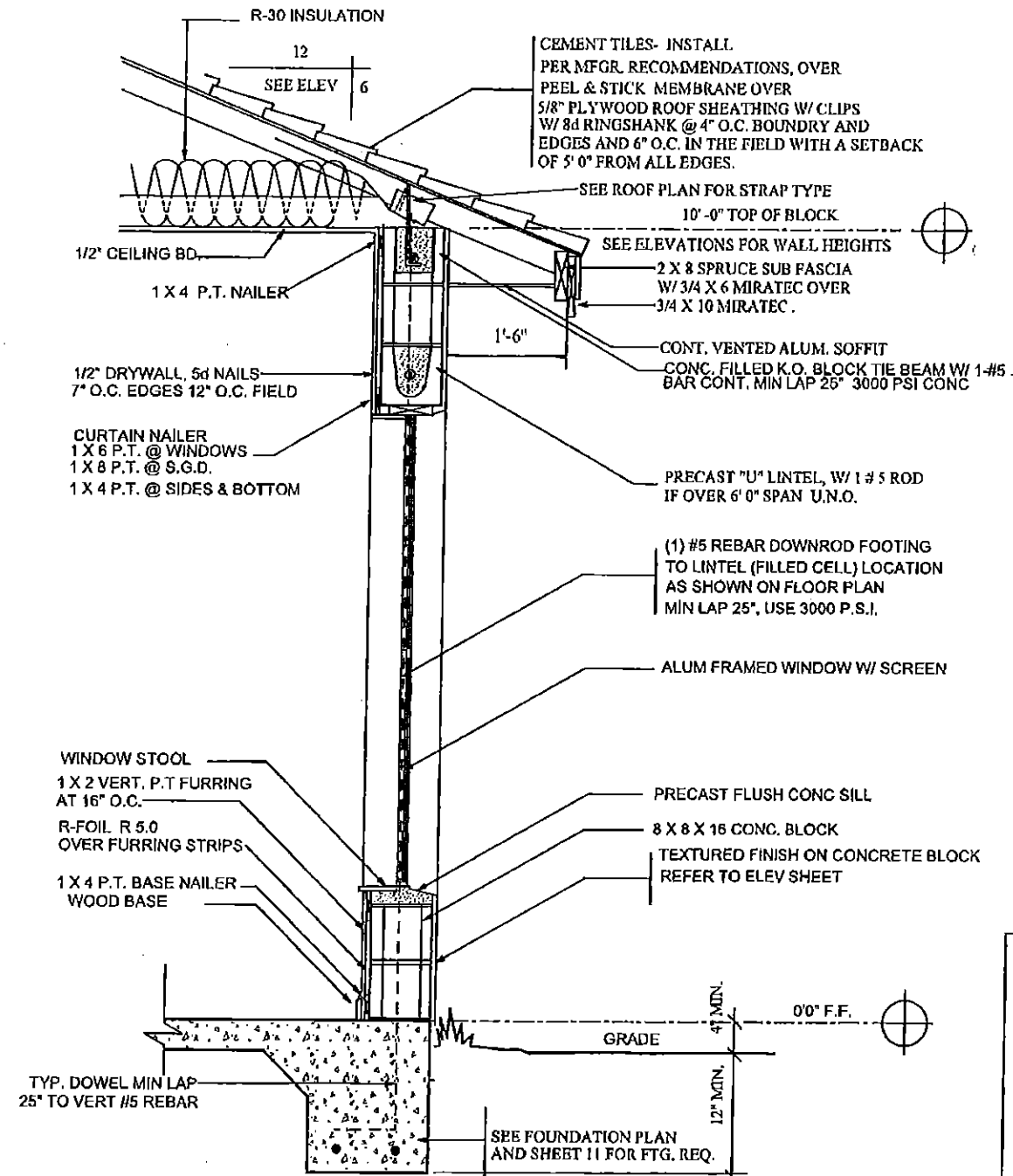

TYPICAL WALL SECTION

TERMITE SPECIFICATIONS:
INSTALL "BORA-CARE" TERMITE PROTECTION SYSTEM PER MANUF. SPECIFICATIONS

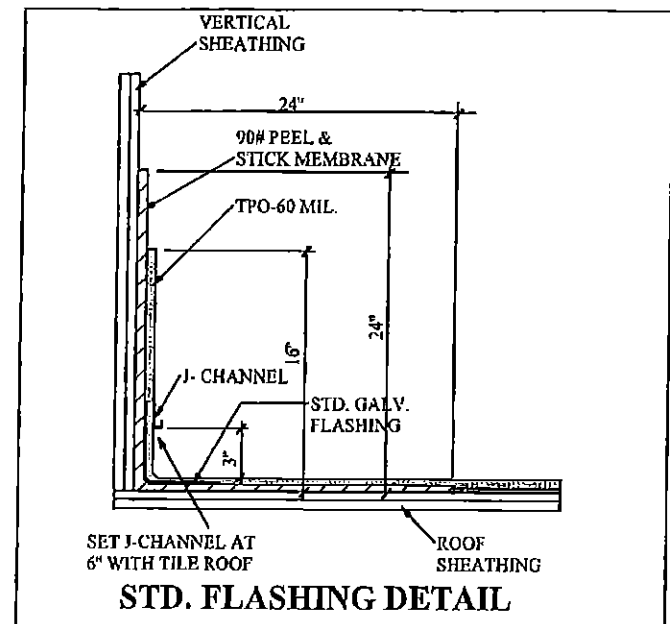
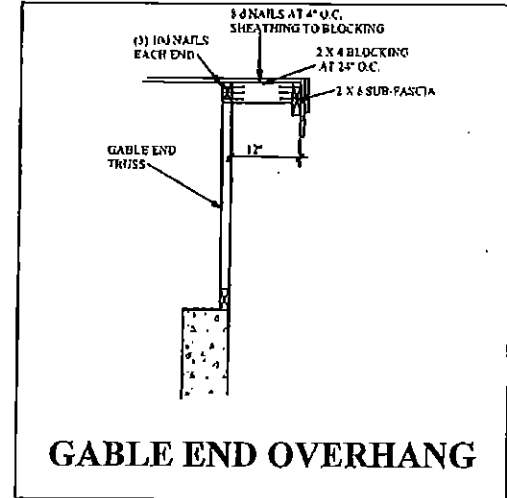
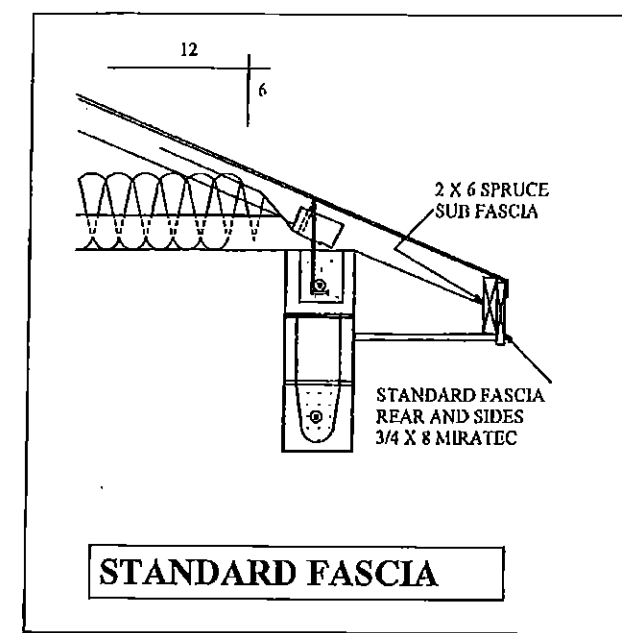

CONST. DETAILS

ASPEN 3503
AECS 14014

ALLEN ENGINEERING & CONSTRUCTION SERVICES
RICH ALLEN PROFESSIONAL ENGINEER
P.E. # 56928 C.A.# 9542
P.O. BOX 351
NEW PORT RICHEY, FL. 34655
727-842-6100 Fax: 727-825-9973
ricball@ape@gmail.com

I HEREBY CERTIFY THAT I HAVE PREPARED THE ATTACHED DESIGN TO COMPLY WITH ALL APPLICABLE CODES AND REGULATIONS AND THAT I AM IN COMPLIANCE WITH ALL REQUIREMENTS OF THE FLORIDA RESIDENTIAL BUILDING CODE. SEAL FOR PROFESSIONAL USE ONLY. RICHARD E. ALLEN P.E. 56928

INVENTORY
LOT 40 MAJESTIC OAKS
PINELLAS COUNTY, FL.

PLAN DATE	2-10-2014
-----------	-----------

DEEB FAMILY HOMES, LTD.
9400 RIVER CROSSING BLD.
NEW PORT RICHEY, FL. 34655
727-376-6831

10

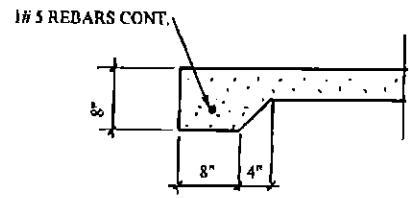

8" THICKENED SLAB (J)

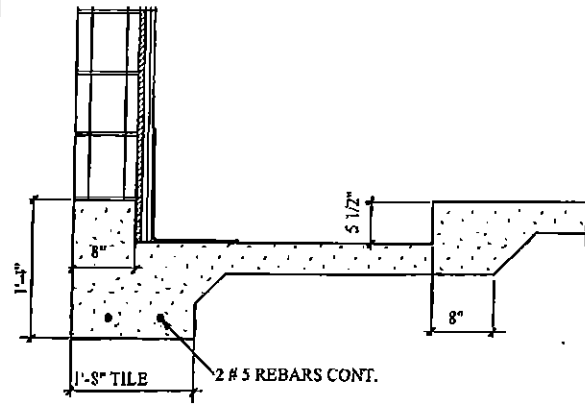

SHOWER RECESS (G)

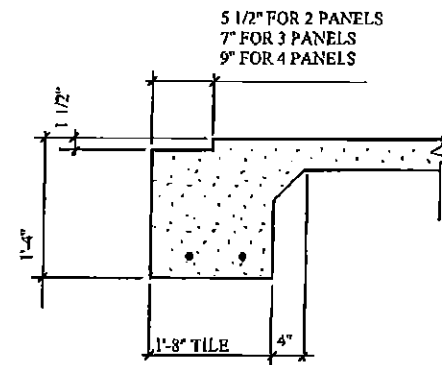

SLIDING GLASS DR. RECESS (D)

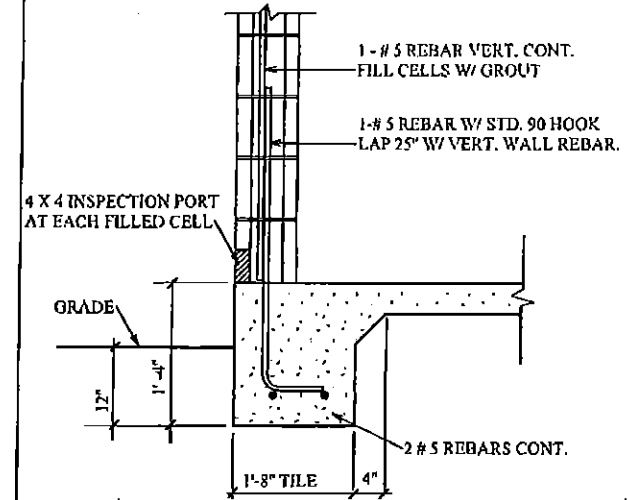

TYPICAL ONE STORY (A)

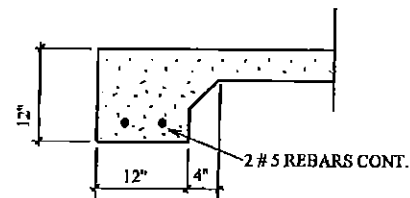

12" THICKENED SLAB (K)

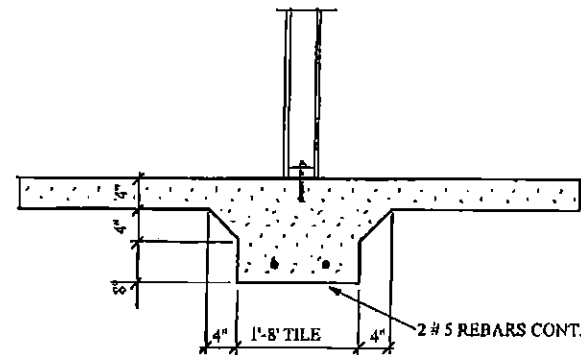

INTERIOR BEARING FTG. (H)

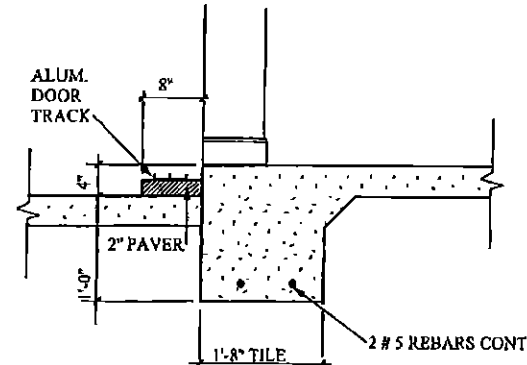

EXTERIOR POCKET S.G.D. (E)

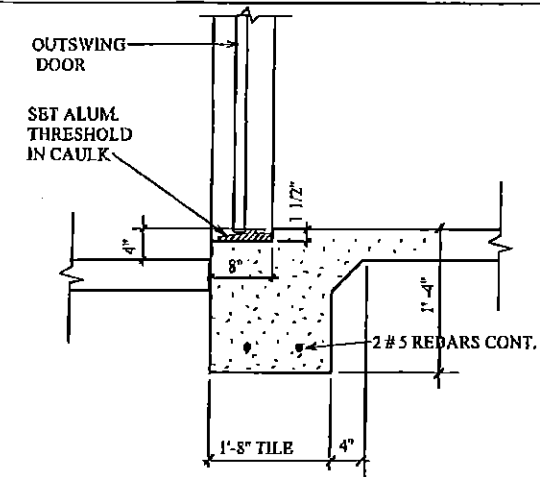

EXTERIOR DOOR RECESS (B)

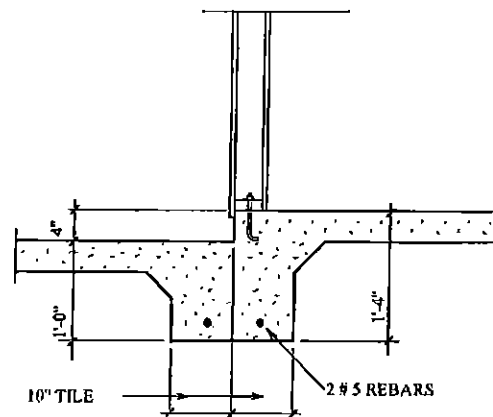

BEARING GARAGE STEP (I)

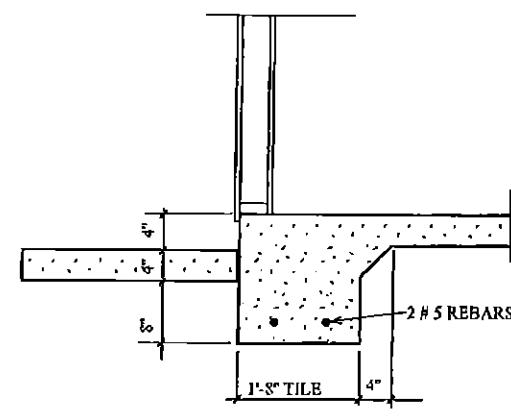

NON-BRG. GARAGE STEP (F)

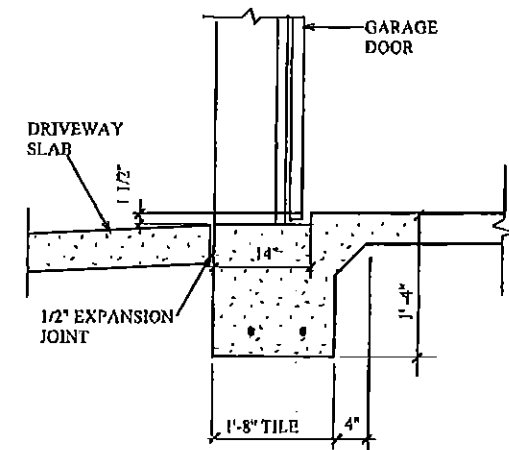

GARAGE DOOR RECESS (C)

FOOTING DETAILS

ASPEN 3503

AECS 14014

DEEB FAMILY HOMES, LTD.
9400 RIVER CROSSING BLD.
NEW PORT RICHEY, FL. 34655
727-376-6831

INVENTORY LOT # MAJESTIC OAKS
PINELLAS COUNTY, FL.

PLAN DATE

2-10-2014

I HEREBY CERTIFY THAT I HAVE PREPARED THE ATTACHED DESIGN TO COMPLY WITH THE FLORIDA BUILDING CODE AND IT IS IN COMPLIANCE WITH SECTION 630.01 OF THE 2010 FLORIDA BUILDING CODE.
RICHARD E. ALLEN P.L.L.C.
REGISTERED PROFESSIONAL ENGINEER
P.E. # 56920 C.A. # 9542

ALLEN ENGINEERING & CONSTRUCTION SERVICES
RICH ALLEN PROFESSIONAL ENGINEER
P.E. # 56920 C.A. # 9542
P.O. BOX 151
NEW PORT RICHEY, FL. 34656
727-842-6100 Fax: 727-825-3975
richallenpe@gmail.com

11